

SPEEDLINE

PVC Fitting Covers and Jacketing Systems

Catalog and Pricing Guide



Industry leaders in the manufacturing of high gloss
white and colored fitting covers and jacketing

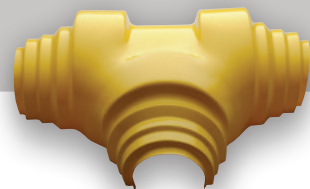
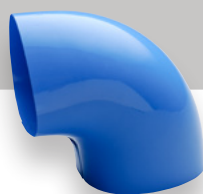

25/50 Smoke-Safe™ PVC

Standard Colors

The colors shown on this page are standard colors available in all Speedline® PVC fitting covers and jacketing. Colors are made-to-order with colored fitting covers and Jacketing having a high gloss finish.

Note: Colored PVC Fitting Covers and Jacketing are not recommended for outdoor use.

	White	
	Light Gray	41619-R1
	Dark Gray	14609-E1
	Black	14587-E1
	Green	41138-R1
	Pea Green	42307-R1
	Light Blue	41073-R1
	Dark Blue	14612-E1
	Purple	41932-R1
	Red	41086-R1
	Orange	41137-R2
	Yellow	41148-R1
	Tan	42438-R1
	Brown	41079-R2

General Information

Service Locations.....	Back Cover
Product Data Sheet.....	2-3
Product Pictures.....	4-5
Application Details.....	6-9
Sizing Charts.....	10, 15, 19, 28, 34
Product Index.....	38
Chart and Data Index.....	38

Pricing

Standard Fitting Covers - White:	
One-Piece 90° Short Radius Elbow Cover.....	11
Tee/Valve Cover.....	11
One-Piece 45° Elbow Cover.....	11
One-Piece 90° Long Radius Elbow Cover.....	12
Oval End Cap Cover.....	13
Round End Cap Cover.....	13
Inline Reducer Cover.....	13
Union Cover.....	14
Flange Cover.....	14
Y-Strainers Cover.....	14
Roof Drain/Sump Cover.....	14
Low Profile Victaulic® Fitting Cover.....	16
Original Victaulic® Fitting Cover.....	17
90° Humped One Piece Short Radius Fitting Covers.....	18
P-Trap Full Profile Covers (PVC).....	18
P-Trap Covering System.....	23

PVC Jacketing

Roll Jacketing - White, Colors & Jumbo.....	20
Cut/Curled Jacketing - White & Colors.....	20
PVC Rod Cover.....	22
PVC Corner Angle.....	22

Accessories

Vinyl Tape - 10 mil & 6 mil.....	21
Stainless Steel Tack Fasteners.....	21
Solvent Weld Adhesive.....	22
Adhesive Thinner.....	22
Silicone Caulking.....	21
Caulking Guns.....	21
Bungee Cord.....	22

Q-Bands.....	21
TRS-10 Fiberglass Insert Blanket.....	22
Adhesive Dispensers.....	22

Fitting Covers - Colors

90° Long Radius Elbow Cover.....	24
90° Short Radius Elbow Cover.....	25
45° Elbow Cover.....	25
Tee/Valve Cover.....	25
Flange Cover.....	26
Union Cover.....	26
Y-Strainer Cover.....	26
Oval / Round End Cap Cover.....	27
Inline Reducer Cover.....	27
Victaulic® Coupling Cover.....	28
Victaulic® Copper Tubing Sizing Chart.....	28
Low Profile Victaulic® Fitting Cover.....	29
Original Victaulic® Fitting Cover.....	30

Heavy Duty Fitting Covers - White

Heavy Duty 90° Short Radius Elbow Cover.....	31
Heavy Duty 45° Elbow Cover.....	31
Heavy Duty Tee/Valve Cover.....	31
Heavy Duty 90° Long Radius Elbow Cover.....	32
Heavy Duty Union Cover.....	33
Heavy Duty Flange Cover.....	33
Heavy Duty Y-Strainer Cover.....	33
Heavy Duty Round End Cap Cover.....	34
Heavy Duty Inline Reducers Cover.....	34

Dimensional Data

Iron Pipe Dimensions.....	36
Screwed Fitting Dimensions.....	36
Welded Fitting Dimensions.....	36 - 37
Victaulic® Fitting Dimensions.....	37
Pipe Flange Dimensions.....	37

Standard Colors.....

Inside front cover

Terms of Sale.....

39

Inserts

Inserts priced with fitting covers will be packaged within the same boxes as the fitting covers unless requested to be packaged separately.

The Speedline® Smoke Safe™ PVC Insulated Fitting Covering System consists of preformed gloss white outdoor weatherable and gloss colored insulated covers for piping fittings. Their unique shapes fit screwed, Victaulic®, welded and flanged elbows, tees, valves, couplings, laterals, reducers and endcaps.

The Speedline® Smoke Safe™ PVC Jacketing System consists of gloss white outdoor weatherable and colored PVC sheet in either bulk rolls or precurled cut-to-fit pipe sizes. The White Jacketing is available in .010", .015", .020", and .030" thicknesses.

The Jacketing and Fitting Covering Systems include solvent weld adhesives, stainless steel tack fasteners, silicone caulking and adhesive tapes. A die-cut multi-temperature fiberglass insulation insert is available and sized for a full insulation over the exposed pipe fitting and under the overlay of the PVC Fitting Cover.

Specification Compliance

ASTM D 1784, Cell Class 16354,
Federal Specification HH-I-558, Form B,
Type 1 Class B (Insert Insulation)
USDA and FDA for use in food processing,
beverage, and pharmaceutical facilities
Military Spec LP-1035A, Type II Grade GU
Military Spec LP-535E, Type II Grade GU
New York City MEA 402-07-M,
Agriculture Canada, Canada: CGSB 51.53-95
CAN/ULC-S102

Applications

Speedline® Smoke Safe™ PVC Insulated Fitting Covers and Jacketing are designed for indoor and outdoor* applications in commercial, institutional and industrial facilities.

- Speedline® Smoke Safe™ PVC Fitting Covers are designed to cover pipe fittings and other mechanical equipment with an outside diameter of 1-5/8" up to 24" in accordance with ASTM C-585. For outdoor use and in high abuse areas, .030 is recommended. For straight runs of piping, expansion joints should always be used to prevent product failure.
- Speedline® Smoke Safe™ PVC jacketing is suitable for covering all flat and round surfaces such as ductwork, tanks and other mechanical equipment. On vessels larger than 24" OD a minimum of .040 Jacketing should be used. For OD's larger than 48", Speedline flat jacketing is not recommended. Due to the expansion and contraction of tanks and vessels, expansion joints should always be used to prevent product failure.
- The Speedline® Smoke Safe™ PVC Jacketing System has an application temperature range of -35°F to 500°F (-37°C to 260°C). The PVC surface should remain below 150°F (66°C) through the installation of sufficient insulation on higher temperature applications.



- **Easy Installation** - the unique shapes make an easy seal over an entire mechanical system
- **Clean, neat and attractive appearance** due to the high gloss PVC surface
- **Low maintenance**
- **Corrosion resistance**
- **Outdoor weatherability*** (UV stable)
- **The 25/50 fire class of all Speedline® Smoke Safe™ products provides greater universal building code acceptance**
- **Provides a natural barrier to moisture, bacteria and mold**

*** Colored fitting covers and jacketing are NOT recommended for outdoor use.**

Physical Properties

Property	Test Method	Value
Speedline® Smoke Safe™ PVC		
Flame Spread	ASTM E84	25 or less
Smoke Developed	ASTM E84	50 or less
Specific Gravity	ASTM 792	1.46
Tensile Strength @ yield lb./in. ²	ASTM D638	7,000
Tensile Modulus PSI	ASTM D638	400,000
Izod Impact- ft.lb./in.	ASTM D256	15.0
Perm Rating @.030"	ASTM E96	0.03
Electrical Conductance	ASTM D257	None
Fiberglass Insulation		
Flame Spread	ASTM E84	25 or less
Smoke Developed	ASTM E84	50 or less
Thermal Conductivity (75°F/24°C)	ASTM C177	0.26

Specification Data

Hot Systems

All piping fittings shall be insulated by filling the total void over all fittings, between straight runs of pipe insulation, with Speedline® die-cut fiberglass insulation, forming a uniform insulation thickness equal to or exceeding the adjacent pipe insulation. Finish all insulated pipe fittings by applying Speedline® Smoke Safe™ PVC Fitting Covers overlapping the adjacent pipe insulation outer covering. Secure the Speedline® Fitting Covers with Speedline® Stainless Steel Tack Fasteners, Speedline® PVC Tape or by welding PVC overlaps with Speedline® Solvent Weld Adhesive. Caution should be exercised to be sure that the insulation surface temperature is maintained below 150°F (66°C) through the application of sufficient insulation under all PVC Covering.

Cold Systems

All piping fittings shall be insulated by filling the total void over all pipe fittings between straight runs of pipe insulation with Speedline® die-cut fiberglass insulation, forming a uniform insulation thickness equal to, or exceeding, the adjacent pipe insulation. Finish all insulated pipe fittings by applying Speedline® Smoke Safe™ PVC Fitting Covers overlapping the adjacent pipe insulation outer covering. The overlap of the throat of the PVC Fitting Cover and the ends of the Fitting Cover overlapping the adjacent pipe insulation vapor barrier jacketing shall be vapor sealed with compatible vapor barrier mastic. The ends of the PVC Fitting Cover overlapping the adjacent pipe insulation shall be further sealed by an outer wrapping of Speedline® PVC Tape extending over the adjacent pipe insulation vapor barrier jacketing and overlapping its own circumferential juncture by at least two inches in the downward direction on the downward side.

Chemical Resistance

Inorganic Acids

Sulfuric, nitric, hydrochloric, hydrofluoric (diluted or concentrated): Excellent

Organic Acids

Formic, acetic and propionic: Poor

Alkalies

Sodium and potassium hydroxides: Excellent
 Ammonium hydroxide: Excellent
 Caustic Soda: Excellent
 Soda Ash: Excellent

Miscellaneous Corrosive Chemicals

Phenol, resorcinol and creosol: Poor
 Iodine, crystals: Fair
 Iodine, tincture: Excellent
 Chlorine and bromine water: Excellent
 Potassium dichromate: Excellent
 Silver nitrate: Excellent
 Tannic acid: Excellent

Solvent and Dilutents

Alcohol and polyalcohols, including ethyl methanol, butanol and isopropyl alcohol: Excellent

Ketones

Lower boiling ketones: Dissolves
 Higher boiling ketones: Swells

Ethers

Ethyl: Softens
 Dichlorethyl ether: Swells
 Diethyl cellosolve: Swells
 Dioxane: Dissolves
 Propylene oxide: Dissolves

Hydrocarbons

Aromatics as gasoline, kerosene and petroleum oils: Excellent

Oils, Fats and Waxes

Animal, mineral and vegetable: Excellent



90° Short Radius Elbow Cover pages 1, 25, 31



45° Elbow Cover pages 11, 25, 31



Oval End Cap pages 13, 27



90° Long Radius Elbow Cover pages 12, 24, 32



Tee/Valve Cover (shown flat) pages 11, 25, 31



Round End Cap pages 13, 27, 34

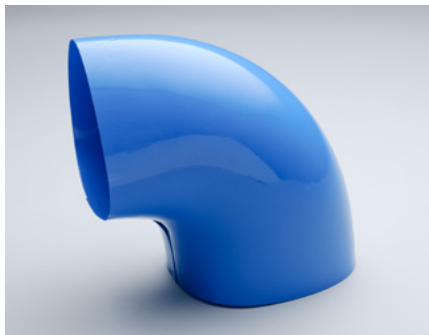

See inside front cover for standard colors pages 24–30



Y-Strainer (Lateral) Cover pages 14, 26, 33



Reducer pages 13, 27, 34



Union Covers pages 14, 26, 33



P-Trap Covers pages 18, 23



PVC Banding and Banding Tools. page 21



Low Profile Victaulic® 90° and 45° Elbow Covers (45° Shown above) page 16,29



Low Profile Victaulic® Tee Cover pages 16, 29



Victaulic® Coupling Cover pages 16, 28



Original Sealed Victaulic® 90° Elbow Cover pages 17, 30



Original Sealed Victaulic® 45° Elbow Cover pages 17, 30



Original Two Piece Victaulic® Tee Cover pages 17, 30

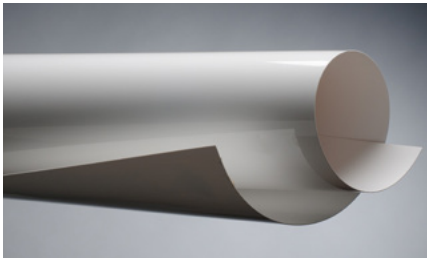

PVC Roll Jacketing page 20



Flange Coupling Cover pages 14, 26, 33



Roof Drain/Sump Cover page 14



Rod Covers page 22



Cut/Curled PVC Jacketing page 20



Solvent Weld Adhesives, Dispensers page 22

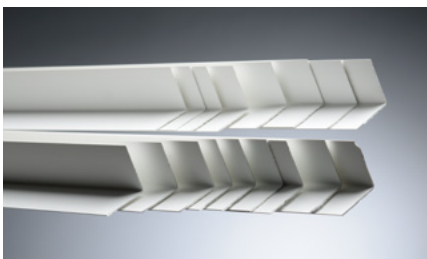

Corner Angles page 22



White Vinyl Tape page 21



Silicone Caulking Compound, Caulking Guns page 21

PVC Fitting Covers Application Details

Hot Systems

All piping fittings shall be insulated by filling the total void over all fittings between straight runs of pipe insulation with Speedline® die-cut fiberglass insulation, forming a uniform insulation thickness equal to, or exceeding, the adjacent pipe insulation.

Finish all insulated pipe fittings by applying Speedline® Smoke Safe™ PVC Fitting Covers overlapping the adjacent pipe insulation outer covering. Secure the Speedline® Fitting Covers with Speedline® Stainless Steel Tack Fasteners, Speedline® PVC Tape, or by welding PVC overlaps with Speedline® Solvent Weld Adhesive. Caution should be exercised to be sure that the insulation surface temperature is maintained below 150°F (66°C) through the application of sufficient insulation under all PVC Covering.



Cold Systems

All piping fittings shall be insulated by filling the total void over all fittings between straight runs of pipe insulation with Speedline® die-cut fiberglass insulation, forming a uniform insulation thickness equal to, or exceeding, the adjacent pipe insulation.

Finish all insulated pipe fittings by applying Speedline® Smoke Safe™ PVC Fitting Covers overlapping the adjacent pipe insulation outer covering. The overlap of the throat of the PVC Fitting Cover and the ends of the Fitting Cover overlapping the adjacent pipe insulation vapor barrier jacketing shall be vapor sealed with compatible vapor barrier mastic. The ends of the PVC Fitting Cover overlapping the adjacent pipe insulation shall be further sealed by an outer wrapping of Speedline® PVC Tape. The PVC Tape should extend over the adjacent pipe insulation vapor barrier jacketing and overlap its own circumferential juncture by at least two inches in the downward direction on the downward side.



Sealed System (USDA) for Fitting Covers and Jacketing Installation Details

All piping fittings shall be insulated by filling the total void over all fittings, between straight runs of pipe insulation, with Speedline® die cut fiberglass insulation, forming a uniform insulation thickness equal to, or exceeding, the adjacent pipe insulation.

Finish all insulated pipe fittings by applying Speedline® Smoke Safe™ Heavy Duty PVC Fitting Covers overlapping the adjacent pipe insulation outer covering. Seal the throat of the PVC Cover by laying a bead of Speedline® Solvent Weld Adhesive on the underside of the overlap.

Install pre-curved cut-to-size 20 mil or 30 mil Speedline® Smoke Safe™ Jacketing with the end overlapping the Heavy Duty PVC Fitting Cover by one or more inches and each progressive section likewise overlapping the prior section. All longitudinal and circumferential overlaps shall be sealed by laying a bead of Speedline® Clear or White Solvent Weld Adhesive on the underside of the overlap. The sealed laps shall be held firmly in place for at least 10 minutes of initial set; final cure occurs over the first 10 hours.

An allowance for expansion shall be provided on all sealed system applications by providing slip-joints as required between rigid pipe supports, on long pipe runs, etc. Slip-joints shall be 6 to 8 inch jacketing overlaps sealed with non-hardening mastic.

Hot Systems

Caution should be exercised to be sure that the insulation surface temperature is maintained below 150°F (66°C) through the application of sufficient insulation under all PVC Covering. The PVC Fitting Covers and Jacketing should be further protected from any direct or radiant exposure to heat exceeding 150°F (66°C).

Note: High temperature installation should incorporate slip-joints to compensate for thermal expansion and contraction of the piping system. Slip-joints can be performed by applying white flexible caulking to the overlap between jacket systems.

Cold Systems

For refrigerant lines and colder, a vapor barrier jacketing will be provided under the outer wrapping of the PVC Jacketing. The fitting insulation should be vapor sealed with vapor barrier mastic prior to the installation of the PVC Fitting Cover.



Low Profile Victaulic® Fitting Cover Installation Data

After securing a sufficient amount of fiberglass fitting insulation blanket over all surfaces of the Victaulic® elbow or tee, the following installation details are suggested for utilizing Speedline Low Profile Victaulic® Fitting Covers.

Sizing Fitting Covers

Before joining the two halves of the PVC Covers, trim off the outer stepped-down ends to the size of the adjoining pipe insulation (see available sizes below). Trim off the appropriate step along its outer edge, retaining a wide flat surface to rest solidly onto the adjoining pipe insulation (see picture to right).

Once trimmed to size, the two halves can be joined with White SS Tack Fasteners for ease of installation. Align the SS Tack Fasteners piercing the dimples along the heel/centerline of the cover. Insert the tacks into the outer half first and then push them through the corresponding dimples of the inner half, working from the centermost points outward.

Pipe Size	Available Flange OD	Max. OD
2"	2 × ½", 1", 1½", 2"	7⅜"
2½"	2½ × ½", 1", 1½", 2"	7⅝"
3"	3 × ½", 1", 1½", 2"	7⅞"
4"	4 × ½", 1", 1½", 2", 2½"	9⅝"
5"	5 × ½", 1", 1½", 2"	11¼"
6"	6 × ½", 1", 1½", 2", 2½"	11¾"
8"	8 × ½", 1", 1½", 2", 3"	15"
10"	10 × 1", 1½", 2", 3½"	18"
12"	12 × 1", 1½", 2", 3½"	20"
14"	14 × 1", 1½", 2", 4"	22"

Two or More Fittings with a Common Grooved Coupling

All Low Profile Victaulic® Fitting Covers have a grooved line defining the center line of the Victaulic® Grooved Coupling. By cutting off one Fitting Cover along this line, and the second Fitting Cover ⅛" into the outer edge of the large flange, you have a geometrically matched pair (see picture to the right). Since this center line is either at the crotch of the fitting cover or before the crotch, the two overlapping Fitting Covers can be rotated to any angle (see picture on next page).

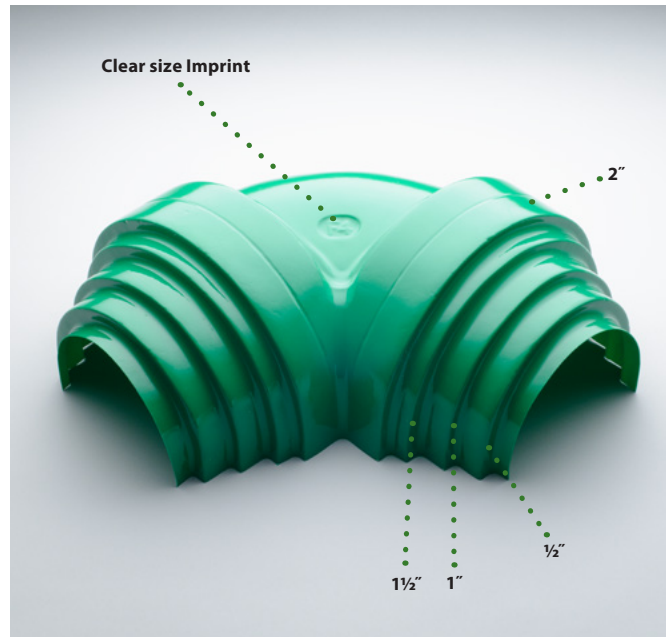

Cut off the right half and the left half along the outer edge (in ⅛") of the largest flange; cut off the right and left halves along the scribe line/centerline of the large flange; install the shorter/second cut halves over the top of the first cut halves, pressing the inside lip of the outer half against the outer edge of the first cut – a dimensionally correct combination results!

Low Profile Victaulic® Fitting Cover Installation Data (continued)

Two or More Fittings with a Common Grooved Coupling and a Pipe Size Reduction

Starting with the larger Fitting Cover, cut off the outer portion making the cut along the centerline molded into the large flange. Attach a Speedline Reducer onto and tightly against the cut edge; attach with PVC Tape, Speedline Solvent Weld Adhesive, or another suitable adhesive. Cut off the end of the smaller Fitting Cover, making the cut along the centerline molded into the large flange; attach the cut edge tightly to the lesser step of the Speedline Reducer (see picture to right).

Example (as shown):

The picture shows the covering for a 6" x 6" x 3" Victaulic® Tee with a directly attached (common coupling cover) 3" 90° Victaulic® Elbow. The two ends of the 6" Tee Cover are cut off to cover 6 x 2 Fiberglass Pipe Covering. The third leg of the Tee Cover is cut to receive an 1 1/4" to 7/8" Speedline Reducer. The 3" Elbow Cover is cut off on the **centerline groove** on the upper end. The downstream end is cut off on the 1/2" flange to cover 3 x 1/2 Fiberglass Pipe Covering.

The sizing of the Speedline Reducer can be taken from the **Max. OD** column on the preceding page, as 1 1/4" OD for a 6" cover and a 7/8" OD for a 3" cover.



The picture to the right shows many of the challenging problems encountered when covering Victaulic® type grooved pipes. Our innovative Low Profile Covers provide the solutions to your needs.



PVC Fitting Cover Sizing Charts

Speedline Smoke-Safe™ PVC Fitting Covers are furnished in generic sizes where possible and specific individual sizes where required. Generic fitting cover sizes comply with pipe insulation dimensional standards ASTM C-585. Generic sizes extend from a #2 (1½" OD) through a #37 (28" OD); see Charts A and B.

Chart A - Iron Pipe Sizes									
Pipe Size	Insulation Thickness (in.)								
	½	JM Knauf	1	1½	2	2½	3	3½	4
¾	2		7	9					
½	3		7	10	12	15	17	18	19
¾	5	4	7	10	12	15	17	18	19
1	5		9	11	13	15	17	18	19
1¼	7	6	9	12	13	15	17	18	19
1½	7		10	12	15	17	18	19	20
2	9		11	13	15	17	18	19	20
2½	10		12	15	17	18	19	20	21
3	11		13	15	17	18	19	20	21
3½	12		15	17	18	19	20	21	22
4	13		15	17	18	19	20	21	22
5	15		17	18	19	20	21	22	23
6	17		18	19	20	21	22	23	24
8	19		20	21	22	23	24	25	26
10	21		22	23	24	25	26	27	28
12			24	25	26	27	28	29	30
14			25	26	27	28	29	30	31
16			27	28	29	30	31	32	33
18			29	30	31	32	33	34	35
20			31	32	33	34	35	36	37

Note: Those 90° Long Radius Elbow sizes falling within the shaded areas of Chart A require special specific sizes (pipe size x insulation thickness). Generic/short radius sizes can be substituted for long radius sizes for unshaded sizes of Chart A.

Chart B - Copper Tubing Sizes										
Pipe Size	OD	Insulation Thickness (in.)								
		½	JM Knauf	1	1½	2	2½	3	3½	4
¾	½		5	5	9	11	13	15		
½	¾	3	2	7	9	11	13	15		
¾	7/8	3	7	7	10	12	15	17	18	19
1	1½	5	4	7	10	12	15	17	18	19
1¼	1¾	5	9	9	11	13	15	17	18	19
1½	1¾	7	6	9	12	13	15	17	18	19
2	2½	9	8	10	12	15	17	18	19	20
2½	2¾	10	9	11	13	15	17	18	19	20
3	3¾	11	10	12	15	17	18	19	20	21
3½	3¾	11	13	13	15	17	18	19	20	21
4	4¾	13	12	15	17	18	19	20	21	22
5	5¾	15	14	17	18	19	20	21	22	23
6	6¾	17	16	18	19	20	21	22	23	24

Chart C - Actual Outer Diameter of Numbered Sizes		
Generic #	PVC Fitting Cover	
	Inches	Centimeters
2	1½	4.128
3	1¾	4.763
4	2½	5.398
5	2¾	6.033
6	2¾	6.668
7	2¾	7.303
8	3½	7.938
9	3½	8.890
10	4	10.160
11	4½	11.430
12	5	12.700
13	5½	14.129
14	6½	15.558
15	6½	16.828
17	7½	19.368
18	8½	21.908
19	9½	24.448
20	10¾	27.305
21	11¾	29.845
22	12¾	32.385
23	14	35.560
24	15	38.100
25	16	40.640
26	17	43.180
27	18	45.720
28	19	48.260
29	20	50.800
30	21	53.340
31	22	55.880
32	23	58.420
33	24	60.960
34	25	63.500
35	26	66.040
36	27	68.580
37	28	71.120
38	29	73.660

90° and 45° Short Radius Fitting Covers - White

Size	OD	Without Insert	Insert Price	With Insert	Pcs./ Ctn.
2	1½	\$.60	\$.10	\$.70	100
3	1¾	.66	.10	.76	100
4	2½	.70	.13	.83	50
5	2¾	.73	.13	.86	50
6	2⅝	.81	.15	.96	50
7	2⅞	.86	.15	1.01	50
8	3⅝	1.09	.15	1.24	50
9	3½	1.14	.15	1.29	50
10	4	1.46	.30	1.76	25
11	4½	1.93	.30	2.23	25
12	5	2.18	.30	2.48	25
13	5⅙	2.40	.55	2.95	25
14	6⅛	4.76	.55	5.31	25
15	6⅝	4.99	.55	5.54	25
16	7⅛	6.37	.55	6.92	25
17	7⅝	6.37	.92	7.29	10
18	8⅝	7.62	.92	8.54	10
19	9⅝	9.51	2.24	11.75	10
20	10¾	11.83	2.24	14.07	10
21	11¾	13.53	2.24	15.77	10
22	12¾	16.98	3.90	20.88	5
23	14	19.50	3.90	23.40	5
24	15	24.00	3.90	27.90	5
25	16	31.00	3.90	34.90	5
26	17	31.60	8.70	40.30	5
27	18	39.10	10.11	49.21	5
28	19	56.15	14.90	71.05	5
29	20	71.25	16.50	87.75	5
30	21	79.70	-	-	5
31	22	96.15	-	-	5

Tee/Valve Covers - White

Size	OD	Without Insert	Insert Price	With Insert	Pcs./ Ctn.
2	1½	\$.98	\$.15	\$ 1.13	100
3	1¾	1.01	.15	1.16	100
4	2½	1.19	.19	1.38	50
5	2¾	1.25	.19	1.44	50
6	2⅝	1.50	.34	1.84	50
7	2⅞	1.51	.34	1.85	50
8	3⅝	1.94	.34	2.28	50
9	3½	1.95	.34	2.29	50
10	4	2.27	.61	2.88	25
11	4½	2.84	.61	3.45	25
12	5	3.38	.61	3.99	25
13	5⅙	4.54	.65	5.19	25
14	6⅛	7.30	.65	7.95	25
15	6⅝	7.33	.81	8.14	25
16	7⅛	14.65	.81	15.46	25
17	7⅝	14.69	1.60	16.29	10
18	8⅝	16.24	1.60	17.84	10
19	9⅝	20.16	4.20	24.36	10
20	10¾	22.78	4.20	26.98	10
21	11¾	25.28	4.20	29.48	10
22	12¾	27.93	5.64	33.57	5
23	14	29.41	5.64	35.05	5
24	15	31.63	5.64	37.27	5
25	16	34.06	5.64	39.70	5
26	17	37.62	6.04	43.66	5

Also available in colors for an additional charge. Call for details.

Also available for high temperature applications, up to 190°F @ 64PSI (per ASTM D648).

Note: For an insulation thickness of 2" or more use more than one insert as needed.



90° Elbow Cover



45° Elbow Cover



Tee/Valve Cover

90° Long Radius One-Piece Fitting Covers - White

Size	Without Insert	Insert Price	With Insert	Pcs./ Ctn.
A 1½ × 1	\$ 3.20	\$.45	\$ 3.65	25
A 1½ × 1½	3.35	.45	3.80	25
2 × 1	3.45	.45	3.90	25
A 2 × 1½	3.99	.45	4.44	25
B 2 × 2½	7.80	.45	8.25	10
B 2 × 3	13.51	.45	13.96	10
A 2½ × 1	3.99	.60	4.59	25
A 2½ × 1½	5.71	.60	6.31	25
B 2½ × 2½	8.70	.60	9.30	10
B 2½ × 3	14.39	.60	14.99	10
3 × 1	3.99	.80	4.79	25
3 × 1½	4.70	.80	5.50	25
3 × 2	6.58	.80	7.38	25
B 3 × 2½	12.88	.80	13.68	10
B 3 × 3	18.14	.80	18.94	10
4 × 1	6.00	1.05	7.05	25
4 × 1½	7.57	1.05	8.62	25
4 × 2	8.44	1.05	9.49	25
B 4 × 2½	19.97	1.05	21.02	10
B 4 × 3	21.03	1.05	22.08	10
5 × 1	7.36	2.00	9.36	10
5 × 1½	7.87	2.00	9.87	10
5 × 2	10.93	2.00	12.93	10
A 5 × 2½	20.90	2.00	22.90	10
A 5 × 3	24.90	2.00	26.90	10
5 × 3½	25.65	2.55	28.20	10
A 5 × 4	26.00	2.55	28.55	10
6 × 1	8.43	2.55	10.98	10
6 × 1½	10.40	2.55	12.95	10
6 × 2	13.74	2.55	16.29	10
A 6 × 2½	25.28	2.55	27.83	10
A 6 × 3	33.25	2.55	35.77	10
A 6 × 3½	35.65	2.55	38.20	10
A 6 × 4	46.75	2.55	49.30	10
8 × 1	12.60	2.55	15.15	10
8 × 1½	13.87	2.55	16.42	10
8 × 2	19.38	2.55	21.93	10
A 8 × 2½	33.85	2.62	36.47	10
A 8 × 3	46.75	2.62	49.37	5
A 8 × 3½	49.65	2.62	52.27	5
A 8 × 4	58.70	2.62	61.32	5
10 × 1	18.57	3.70	22.27	5
10 × 1½	20.35	3.70	24.05	5
10 × 2	23.43	3.70	27.13	5
A 10 × 2½	48.00	3.70	51.70	5
A 10 × 3	60.75	3.70	64.45	5

Size	Without Insert	Insert Price	With Insert	Pcs./ Ctn.
A 10 × 3½	\$ 61.25	\$ 3.70	\$ 64.95	5
A 10 × 4	82.80	3.70	86.50	5
12 × 1	32.00	4.90	36.90	5
12 × 1½	38.00	4.90	42.90	5
12 × 2	40.00	4.90	44.90	5
A 12 × 2½	61.25	4.90	66.15	5
A 12 × 3	75.25	4.90	80.15	5
A 12 × 3½	89.50	4.90	94.40	5
A 12 × 4	95.95	4.90	100.85	5
A 14 × 1	40.00	6.55	46.55	5
A 14 × 1½	45.00	6.55	51.55	5
A 14 × 2	48.00	6.55	54.55	5
A 14 × 2½	88.80	-	-	5
A 14 × 3	92.25	-	-	5
A 14 × 3½	95.25	-	-	5
A 16 × 1	78.05	9.70	87.75	5
A 16 × 1½	78.05	9.70	87.75	5
A 16 × 2	85.90	9.70	95.60	5
A 16 × 2½	85.90	-	-	5
18 × 1	99.60	Two-Piece Unsealed	-	5
18 × 1½	99.60	Two-Piece Unsealed	-	5
18 × 2	110.35	Two-Piece Unsealed	-	5
C 20 × 1	159.49	-	-	3
C 20 × 2	177.72	-	-	3
C 20 × 3	195.94	-	-	3
C 24 × 1½	205.06	-	-	3
C 24 × 2	214.17	-	-	3

- A** Sealed two-piece fitting covers
- B** Provided as the equivalent numbered short radius elbow cover
- C** Unsealed four-piece fitting cover

Note: For an insulation thickness of 2" or more use more than one insert as needed.



90° Long Radius Ell Cover

End Caps - White Standard Oval and Round

Size	OD	List Price	Pcs./ Ctn.
2	1½	\$.20	100
3	1¾	.23	100
4	2¼	.26	50
5	2¾	.31	50
6	2¾	.45	50
7	2¾	.47	50
8	3¼	.65	50
9	3½	.73	50
10	4	.73	50
11	4½	.83	50
12	5	.91	50
13	5¼	1.22	50
14	6¼	1.60	50
15	6¾	2.12	50
16	7¼	2.50	50
17	7¾	2.95	50
18	8¾	3.27	50
19	9¾	3.93	15
20	10¾	4.28	15
21	11¾	4.85	15
22	12¾	5.36	15
23	14	7.45	15
24	15	7.84	15
25	16	8.14	15
26	17	11.25	t/o
27	18	13.00	t/o
28	19	15.25	t/o
29	20	16.65	t/o
30	21	21.80	t/o
31	22	24.20	t/o
32	23	24.90	t/o
33	24	26.80	t/o
34	25	28.25	t/o
35	26	28.83	t/o
36	27	29.42	t/o
37	28	30.02	t/o
38	29	30.64	t/o
39	30	31.27	t/o
40	31	33.25	t/o
41	32	34.60	t/o
42	33	35.50	t/o
43	34	36.45	t/o
44	35	37.60	t/o
45	36	38.50	t/o
46	37	39.35	t/o
47	38	40.25	t/o

Note: Shaded sizes are available in **Round End Caps** only and packaged to order.

Oval (adjustable) End Caps have a cross scribe line for field cutting; this cut allows an overlapping of two halves for a neat circumferential cap. The Oval End Caps also have circular scribe lines providing a quick easy guide to cutting out the cap's inside, producing a simple reducer. The Round End Caps are a neat circular cap of an outside diameter of standard pipe insulation dimensions.



Oval End Cap



Round End Cap

Inline Reducers are round reducers providing an easy, neat reduction from one insulation outside diameter to another. They are formed as full round bodies with generous full extensions.

Inline Reducers - White

Larger P/C OD	List Price	Larger P/C OD	List Price
2¾	\$ 1.71	19	\$ 18.59
2¾	1.76	20	19.58
3½	1.82	21	20.63
4	2.04	22	22.11
4½	2.26	23	22.72
5	2.64	24	22.72
5¼	2.97	25	24.75
6¾	3.25	26	26.13
7¾	4.84	27	27.12
8¾	4.95	28	28.22
9¾	5.39	29	30.58
10¾	5.67	30	31.63
11¾	6.22	31	34.05
12¾	7.04	32	35.75
14	11.61	33	37.84
15	12.05	34	39.60
16	13.64	35	41.75
17	15.13	36	44.00
18	16.50		



Reducer

Note: Reducers are packaged to order. Price covers by the larger OD and state the required reduced size when ordering. An example 8¾" OD (@ \$4.95) reduced to 6¾". Covers are provided without inserts.



Y-Strainer (Lateral)



Union Cover



Flange Coupling Cover

Y-Strainer - White (Packaged to Order)		
Size	OD	List Price
7	2 ⁷ / ₈	\$ 6.44
9	3 ¹ / ₂	11.39
10	4	15.22
11	4 ¹ / ₂	15.87
12	5	16.15
13	5 ⁵ / ₁₆	22.40
14	6 ¹ / ₈	23.43
15	6 ⁵ / ₈	24.10
17	7 ⁷ / ₈	32.79
18	8 ⁵ / ₈	34.39
19	9 ⁵ / ₈	38.81
20	10 ³ / ₄	39.62
21	11 ³ / ₄	42.37
22	12 ³ / ₄	45.96

Union Covers - White (Packaged to Order)		
Size	OD	List Price
7	2 ⁷ / ₈	\$ 3.30
9	3 ¹ / ₂	3.85
10	4	4.02
11	4 ¹ / ₂	5.28
12	5	5.61
13	5 ⁵ / ₁₆	5.72
15	6 ⁵ / ₈	9.35

Flange Covers - White					
Size	OD	Without Insert	Insert Price	With Insert	Pcs./Ctn.
6/7	2 ⁵ / ₈ - 2 ⁷ / ₈	\$ 5.55	\$.44	\$ 5.99	50
8/9	3 ¹ / ₈ - 3 ¹ / ₂	6.59	.64	7.23	50
10/11	4 - 4 ¹ / ₂	6.95	.94	7.89	25
12/13	5 - 5 ⁵ / ₁₆	9.57	1.12	10.69	25
14/15	6 ¹ / ₈ - 6 ⁵ / ₈	10.43	1.43	11.86	10
16/17	7 ¹ / ₈ - 7 ⁵ / ₈	15.04	2.08	17.12	10
18/19	8 ⁵ / ₈ - 9 ⁵ / ₈	17.41	2.54	19.95	10
20/21	10 ³ / ₄ - 11 ³ / ₄	22.42	3.12	25.54	10
22/23	12 ³ / ₄ - 14	28.82	3.71	32.53	10
24/25	15 - 16	29.50	4.31	33.81	10



Roof Drain Cover

The **PVC Roof Drain Cover** covers roof sumps with drain pipe sizes of 4" through 8⁵/₈". The sized-to-order pipe insulation sleeve is an integral part of the Roof Drain Cover.

2" to 8" Roof Drain Cover - 1/2" to 1" Insulation OD (Packaged to order)					
Size	Flange OD	Dimensions (in.)			List Price
		A	B	C	
10	4				
11	4 ¹ / ₂				
12	5				
13	5 ⁵ / ₁₆	20	18	5	\$ 18.40
15	6 ⁵ / ₈				
17	7 ⁵ / ₈				
18	8 ⁵ / ₈				

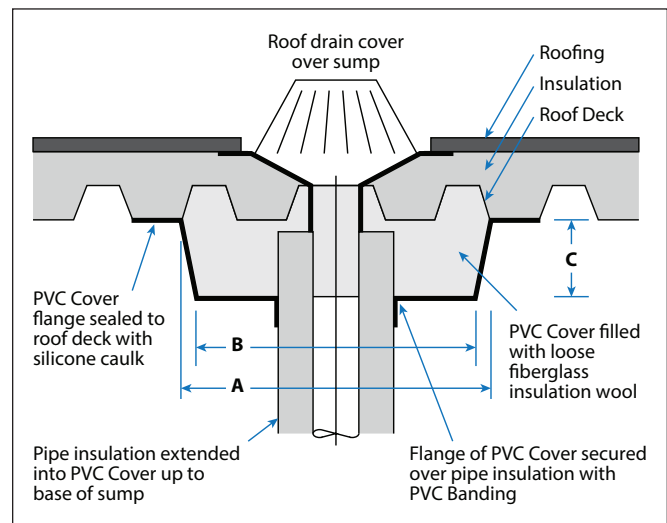

Sizing Chart for Use of Low Profile Victaulic® Fitting Covers on Victaulic® Copper Tubing Fittings						
Tube Size	Fitting Type	Insulation Thickness (in.)				
		½	¾	1	1½	2
2½	90°	2 × ½	2½ × ½	2½ × ½	2½ × 1	2 × 2
	45°	2 × ½	2½ × ½	2½ × ½	2½ × 1	2½ × 1½
	Tee	2 × ½	2½ × ½	2½ × ½	2½ × 1	2 × 2
2¾	90°	2½ × ½	2 × 1	2 × 1	2 × 1½	2 × 2
	45°	2½ × ½	3 × ½	3 × ½	3 × 1	3 × 1½
	Tee	2½ × ½	2 × 1	2 × 1	2 × 1½	2 × 2
3½	90°	3 × ½	2½ × 1	2½ × 1	2½ × 1½	2½ × 2
	45°	3 × ½	2½ × 1	2½ × 1	3 × 1½	3 × 2
	Tee	2½ × 1	2½ × 1	2½ × 1	2½ × 1½	2½ × 2
4½	90°	4 × ½		4 × 1	4 × 1½	4 × 2
	45°	4 × ½		4 × 1	4 × 1½	4 × 2
	Tee	3 × 1		3 × 1½	3 × 2	4 × 2
5½	90°	5 × ½		5 × 1	5 × 1½	5 × 2
	45°	5 × ½		5 × 1	5 × 1½	5 × 2
	Tee	5 × ½		5 × 1	5 × 1½	5 × 2
6½	90°	6 × ½		6 × 1	6 × 1½	6 × 2
	45°	6 × ½		6 × 1	6 × 1½	6 × 2
	Tee	6 × ½		6 × 1	6 × 1½	6 × 2

Each specific size should be cut off at the noted outside diameter to provide a proper fit.

Low Profile Victaulic® Fitting Covers

Each **Victaulic® Type Fitting Cover** has stepped outer laps for neatly overlapping a ½", 1", 1½" or 2" pipe insulation thickness for the pipe sizes shown (10" covers and larger do not have a ½" lap). Additional outer diameters are provided for 4" and larger covers. For example, 14 × 1 through 14 × 4, all in one fitting cover (see page 8 and 9 for all sizes and installation details).



Low Profile Victaulic® Tee Cover



Low Profile Victaulic® 90° and 45° Elbow Cover



Victaulic® Coupling Cover

Larger size Victaulic® Type Coupling Covers will accommodate two different outside diameters.

Victaulic® Tee Covers Low Profile (2 Pc.) - White				
Size	Without Insert	Insert Price	With Insert	Pcs./Ctn.
2	\$ 12.75	\$.83	\$ 13.58	10
2½	13.65	.83	14.48	10
3	15.85	1.04	16.89	10
4	22.75	1.75	24.50	10
5	26.65	1.75	28.40	10
6	31.70	3.42	35.12	10
8	38.15	4.20	42.35	10
10	48.20	5.64	53.84	10
12	63.35	5.64	68.99	t/o
14	65.15	-	-	t/o

Note: For an insulation thickness of 2" or more, use more than one insert as needed.

90° Victaulic® Elbow Covers Low Profile (2 Pc.) - White				
Size	Without Insert	Insert Price	With Insert	Pcs./Ctn.
2	\$ 7.54	\$.64	\$ 8.18	10
2½	8.03	.64	8.67	10
3	9.85	1.06	10.91	10
4	11.99	1.63	13.62	10
5	13.97	2.26	16.23	10
6	18.32	2.55	20.87	10
8	24.37	2.55	26.92	10
10	33.22	3.70	36.92	10
12	55.48	5.18	60.66	5
14	60.23	-	-	5

Victaulic® Coupling Covers - White				
Size	Without Insert	Insert Price	With Insert	Pcs./Ctn.
11	\$ 4.46	\$.52	\$ 4.98	25
12	4.85	.55	5.40	25
13	6.06	.63	6.69	25
15	6.47	.74	7.21	10
17	8.06	.95	9.01	10
18	10.38	1.13	11.51	10
19	17.91	1.58	19.49	10
20	18.99	1.65	20.64	10
21	23.30	2.02	25.32	10
22/23	23.45	2.41	25.86	10
24/25	28.50	2.41	30.91	10
26	34.00	3.39	37.39	10

45° Victaulic® Elbow Covers Low Profile (2 Pc.) - White				
Size	Without Insert	Insert Price	With Insert	Pcs./Ctn.
2	\$ 7.09	\$.64	\$ 7.73	10
2½	7.25	.64	7.89	10
3	9.40	1.06	10.46	10
4	11.45	1.63	13.08	10
5	13.34	2.26	15.60	10
6	17.22	2.55	19.77	10
8	22.79	2.55	25.34	10
10	29.19	3.70	32.89	10
12	44.73	5.18	49.91	t/o
14	49.88	-	-	t/o

Original Sealed Victaulic® Fitting Covers

90° and 45° **Victaulic Elbow Covers** are made in two half sections which are available sealed as a one piece cover (for ease of installation).

Each Fitting Cover has stepped outer laps for neatly overlapping a ½", 1", 1½" or 2" pipe insulation thickness for the pipe sizes shown (see picture for cut-off steps).

Note: For an insulation thickness of 2" or more use more than one insert as needed.

For Victaulic® Type Coupling Covers see page 16.



Original Victaulic® 90° Elbow Cover

90° Victaulic® Elbow Covers Original Sealed - White				
Size	Without Insert	Insert Price	With Insert	Pcs./ Ctn.
2	\$ 10.50	\$.64	\$ 11.14	3
2½	11.20	.64	11.84	3
3	14.33	1.06	15.39	3
4	15.37	1.63	17.00	3
5	22.40	2.26	24.66	3
6	26.62	2.55	29.17	3
8	31.50	2.55	34.05	3
10	37.84	3.70	41.54	3
12	53.24	5.18	58.42	3
14	54.75*	-	-	3

*Not sealed



Original Victaulic® 45° Elbow Cover

45° Victaulic® Elbow Covers Original Sealed - White				
Size	Without Insert	Insert Price	With Insert	Pcs./ Ctn.
2	\$ 9.20	\$.64	\$ 9.84	5
2½	10.10	.64	10.74	5
3	13.65	1.06	14.71	5
4	14.10	1.63	15.73	5
5	19.25	2.26	21.51	5
6	24.85	2.55	27.40	5
8	27.05	2.55	29.60	5
10	32.25	3.70	35.95	5
12	45.10	5.18	50.28	5
14	47.50*	-	-	5

*Not sealed

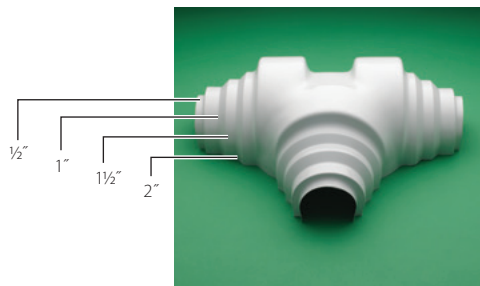

Original Victaulic® Tee Cover

Victaulic® Tee Covers Original (2 Pc.) - White				
Size	Without Insert	Insert Price	With Insert	Pcs./ Ctn.
2	\$ 12.75	\$.83	\$ 13.58	5
2½	13.65	.83	14.48	5
3	15.85	1.04	16.89	5
4	22.75	1.75	24.50	5
5	26.65	1.75	28.40	5
6	31.70	3.42	35.12	5
8	38.15	4.20	42.35	5
10	48.20	5.64	53.84	5
12	63.35	5.64	68.99	5
14	65.15	-	-	5

90° Humped One Piece Short Radius Fitting Covers

Size	White	Color
7	\$ 2.25	\$ 2.81
9	2.65	3.31
10	3.25	4.06
11	3.45	4.31
12	4.30	5.38
13	5.20	6.50
15	6.38	7.98
17	8.10	10.13
18	10.95	13.69
19	14.75	18.44
20	16.75	20.94
21	21.20	26.50
22	25.35	31.70



Speedline® 90° Humped One Piece Short Radius Fitting Covers provide a better fit on oversized short radius fabricated screwed 90° elbows.

P-Trap Full Profile Covers - PVC

Size	List
2 × 1	\$ 21.25
3 × 1	25.25
4 × 1	29.25



PVC Jacketing Sizing Charts

Speedline® Smoke-Safe™ PVC Jacketing is provided cut to size and has a tight curl set into the jacketing. Chart D and E provide incremental sizing for pipe sizes and insulation thickness (for pricing see page 20).

Chart D - Iron Pipe									
Pipe Size	Insulation Thickness (in.)								
	½	1	1½	2	2½	3	3½	4	
¾		3.0	3.5						
½	2.0	3.0	4.0	5.0	6.5	7.5	8.5	9.5	
¾	2.5	3.0	4.0	5.0	6.5	7.5	8.5	9.5	
1	2.5	3.5	4.5	5.5	6.5	7.5	8.5	9.5	
1¼	3.0	3.5	5.0	5.5	6.5	7.5	8.5	9.5	
1½	3.0	4.0	5.0	6.5	7.5	8.5	9.5	10.5	
2	3.5	4.5	5.5	6.5	7.5	8.5	9.5	10.5	
2½	4.0	5.0	6.5	7.5	8.5	9.5	10.5	11.5	
3	4.5	5.5	6.5	7.5	8.5	9.5	10.5	11.5	
3½	5.0	6.5	7.5	8.5	9.5	10.5	11.5	12.5	
4	5.5	6.5	7.5	8.5	9.5	10.5	11.5	12.5	
5	6.5	7.5	8.5	9.5	10.5	11.5	12.5	14.0	
6	7.5	8.5	9.5	10.5	11.5	12.5	14.0	15.0	
8	9.5	10.5	11.5	12.5	14.0	15.0	16.0	17.0	
10	11.5	12.5	14.0	15.0	16.0	17.0	18.0	19.0	
12	14.0	15.0	16.0	17.0	18.0	19.0	20.0	21.0	
14	15.0	16.0	17.0	18.0	19.0	20.0	21.0	22.0	
16	17.0	18.0	19.0	20.0	21.0	22.0	23.0	24.0	
18	19.0	20.0	21.0	22.0	23.0	24.0	25.0	26.0	
20	21.0	22.0	23.0	24.0	25.0	26.0	27.0	28.0	

Chart F - Iron Pipe		
Pipe Size	Actual OD (in.)	PVC Jacket Size
½	.840	½" T
¾	1.050	¾" T
1	1.315	1" T
1¼	1.660	1" T
1½	1.900	1½" T
2	2.375	2.5
2½	2.875	3.0
3	3.500	3.5
3½	4.000	4.0
4	4.500	4.5
5	5.563	5.5
6	6.625	6.5
8	8.625	8.5
10	10.750	10.5
12	12.750	12.5
14	14.000	14.0
16	16.000	16.0
18	18.000	18.0
20	20.000	20.0

Note: The PVC Jacket sizes noted as "T" are sized as "Rod Covering" (page 22).

Chart E - Copper Tubing									
Tube Size	OD	Insulation Thickness (in.)							
		½	1	1½	2	2½	3	3½	4
¾	½		2.5	3.5	4.5	5.5	6.5		
½	⅝	2.0	3.0	3.5	4.5	5.5	6.5		
¾	⅞	2.0	3.0	4.0	5.0	6.5	7.5	8.5	9.5
1	1⅛	2.5	3.0	4.0	5.0	6.5	7.5	8.5	9.5
1¼	1⅜	2.5	3.5	4.5	5.5	6.5	7.5	8.5	9.5
1½	1⅝	3.0	3.5	5.0	5.5	6.5	7.5	8.5	9.5
2	2⅛	3.5	4.0	5.0	6.5	7.5	8.5	9.5	10.5
2½	2⅝	4.0	4.5	5.5	6.5	7.5	8.5	9.5	10.5
3	3⅛	4.5	5.0	6.5	7.5	8.5	9.5	10.5	11.5
3½	3⅝	4.5	5.5	6.5	7.5	8.5	9.5	10.5	11.5
4	4⅛	5.5	6.5	7.5	8.5	9.5	10.5	11.5	12.5
5	5⅝	6.5	7.5	8.5	9.5	10.5	11.5	12.5	14.0
6	6⅛	7.5	8.5	9.5	10.5	11.5	12.5	14.0	15.0

Note: For PVC Cut & Curled Jacket sizes smaller than 2.0 (2" OD) use Rod Covering (page 22).

Cut/Curled Jacketing - 48" Wide White and Color (List Price/Lin. Ft.)				
Size	White		Color	
	.020	.030	.020	.030
1.5	\$.86	\$.99	\$ 1.21	\$ 1.42
2.0	1.14	1.32	1.61	1.89
2.5	1.23	1.52	1.75	2.18
3.0	1.30	1.66	1.84	2.36
3.5	1.34	1.89	1.91	2.70
4.0	1.45	2.09	2.07	2.98
4.5	1.57	2.27	2.25	3.25
5.0	1.73	2.68	2.48	3.77
5.5	1.84	2.82	2.64	4.02
6.0	2.00	3.07	2.80	4.39
6.5	2.02	3.32	2.89	4.75
7.0	2.09	3.55	2.98	5.07
7.5	2.25	3.68	3.20	5.25
8.0	2.45	3.91	3.50	5.59
8.5	2.57	4.18	3.66	5.98
9.0	2.64	4.34	3.77	6.20
9.5	2.75	4.59	3.93	6.57
10.0	2.93	4.77	4.18	6.82
10.5	3.07	5.02	4.39	7.18
11.0	3.11	5.16	4.45	7.36
11.5	3.23	5.73	4.61	8.18
12.0	3.36	5.77	4.80	8.25
12.5	3.43	5.93	4.91	8.48
13.0	3.59	6.00	5.14	8.57
13.5	3.75	6.07	5.36	8.66
14.0	4.16	6.25	5.93	8.93
14.5	4.20	6.30	6.00	9.00
15.0	4.27	6.36	6.11	9.09
16.0	4.43	7.59	6.34	10.84
16.5	4.56	8.23	6.53	11.75
17.0	4.70	8.48	6.73	12.11
17.5	4.77	8.50	6.83	12.15
18.0	4.91	8.52	7.02	12.18
19.0	5.30	9.11	7.57	13.02
20.0	5.66	9.34	8.09	13.34
21.0	5.93	10.25	8.48	14.64
22.0	6.50	11.27	9.30	16.11
23.0	7.05	12.39	10.07	17.70
24.0	7.75	13.61	11.07	19.45
25.0	8.52	15.00	12.18	21.43
26.0	9.36	16.50	13.39	23.57

SSL available at a net \$.08 per lineal foot upcharge.

White Roll Jacketing		
Roll Size	Sq. Ft./ Roll	List Price/ Sq. Ft.
.010" × 35½" × 203'	600	\$.30
.015" × 35½" × 102'	300	.44
.020" × 35½" × 102'	300	.58
.020" × 48" × 100'	400	.58
.030" × 35½" × 102'	300	.79
.030" × 48" × 100'	400	.79
.040" × 48" × 100'	400	1.16

Color Roll Jacketing		
Roll Size	Sq. Ft./ Roll	List Price/ Sq. Ft.
.020" × 48" × 100'	400	\$.73
.030" × 48" × 100'	400	.99

Jumbo Rolls, White and Color (List Price/Sq. Ft.)		
Roll Size	White	Color
.010" × 35.5" × 1,020'	\$.28	N/A
.015" × 35.5" × 618'	.41	N/A
.020" × 35.5" × 515'	.48	N/A
.030" × 35.5" × 309'	.73	N/A
.020" × 48" × 404'	.48	.59
.030" × 48" × 303'	.73	.91

Flat Sheets Available in .020 & .030

Add .10 per Sq. Ft.

An additional skid charge will apply to all sheet orders.



Cut and Curled Jacketing
See sizing chart on page 19.

White Vinyl Tape			
Thick	Size	Rolls/ Carton	List Price (per roll)
6 Mil	1" x 108'	48	\$ 4.85
	1½" x 108'	36	7.25
	2" x 108'	24	9.70
10 Mil	1" x 100'	36	8.25
	1½" x 100'	24	12.40
	2" x 100'	18	16.60

Recommended Width By Insul. OD and Yield Per Roll		
Insul. OD	Tape Width (in.)	Wraps Per Roll w/2" lap
1½	1	168.4
1¾	1	151.2
2½	1	138.2
2¾	1	126.3
2⅝	1	117.1
2⅞	1	108.5
3½	1	101.6
3½	1½	92.3
4	1½	82.4
4½	1½	74.4
5	1½	67.6
5⅙	1½	61.5
6⅙	1½	56.5
6⅝	1½	52.6
7⅙	1½	57.8
7⅝	1½	46.2
8⅙	1½	41.2
9⅙	2	37.2
10¾	2	33.6
11¾	2	30.8
12¾	2	28.5
14	2	26.1
15	2	24.4
16	2	23.0
17	2	21.7
18	2	20.4
19	2	19.4
20	2	18.5
21	2	17.7



PVC Tape – 1", 1½" and 2"

DOW® Silicone Caulk	
Item	List Price/Tube
732 White (USDA)	\$ 9.45
732 Clear (USDA)	9.45

Speedline® Silicone 73-20 Caulk	
Item	List Price/Tube*
73-20 White, Clear & Aluminum (USDA)	\$ 6.25

*12 tubes/case

E-Z Thrust Caulking Gun - Model 111	
Item	List Price
Gun, including seal puncture and tip cut-off tools	\$ 12.95

Fastening Straps Q-Bands, Clips and Tensioner	
Item	List Price
½" x 100' Bands	\$ 18.25/roll
Clips (25/bag)	11.00/bag
Tensioning Gun	98.25/ea.

Stainless Steel Tack Fasteners		
Color	Pcs./Box	List Price/Box
White	500	\$ 26.00



PVC Rod Covers

White PVC Rod Covers	
Rod OD x Length (in.)	List Price/Lin. Ft.
3/8" x 48	\$ 1.65
1/2" x 48	1.65
3/4" x 48	1.80
1" x 48	1.80

Bungee Cord		
Diameter (in.)	Lin. Ft./ Roll	List Price/ Lin. Ft.
3/16	150	\$.40
1/4	150	.48
3/8	100	1.27
1/2	100	3.47

TRS-10 1000°F Fiberglass Insulation Blanket		
Size	Sq. Ft./ Roll	List Price/ Sq. Ft.
1" x 4' x 150'	600	\$.45
1 1/2" x 4' x 100'	400	.67
2" x 4' x 75'	300	.90
3" x 4' x 50'	200	1.35

Net prices for TRS-10 are FOB Greensboro only.

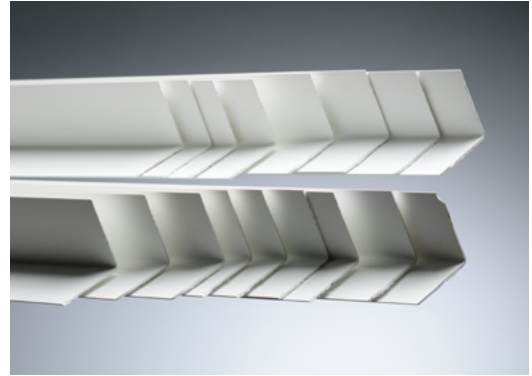

PVC Corner Angles

PVC Corner Angle, Extruded - White	
Size	List Price Each
1 1/2" x 1 1/2" x 8'	\$ 10.70

Solvent Weld Adhesive - White or Clear		
Unit	Units/Case	List Price Each
Quarts	12	\$ 27.50
Gallons	4	89.50

Thinner for Solvent Weld Adhesive	
Unit	List Price Each
Quarts	\$ 19.00
Gallons	61.00

Adhesive Dispensers	
Item	List Price Each
Steel Dispenser w/tip (1 pint/16 floz)	\$ 37.15
Replacement tips (steel)	10.00
Replacement tips (phenolic)	7.50
Plastic Dispenser w/fixed tip (5 oz.)	16.50



Steel Dispenser, 16 oz.



Plastic Dispenser, 5 oz.

90° Long Radius Sealed Two-Piece Fitting Covers - Color

Size	Without Insert	Insert Price	With Insert	Pcs./Ctn.	Size	Without Insert	Insert Price	With Insert	Pcs./Ctn.
1½ × 1	\$ 6.60	\$.30	\$ 6.90	25	10 × 3½	\$ 69.09	\$ 3.70	\$ 72.79	5
1½ × 1½	6.60	.30	6.90	25	10 × 4	88.68	3.70	92.38	5
2 × 1	6.90	.45	7.35	25	12 × 1	39.06	4.90	43.96	5
2 × 1½	6.90	.45	7.35	25	12 × 1½	57.44	4.90	62.34	5
* 2 × 2½	14.39	.60	14.99	10	12 × 2	69.55	4.90	74.45	5
* 2 × 3	18.64	.60	19.24	10	12 × 2½	69.55	4.90	74.45	5
2½ × 1	7.50	.60	8.10	25	12 × 3	81.70	4.90	86.60	5
2½ × 1½	7.50	.60	8.10	25	12 × 3½	102.72	4.90	107.62	5
* 2½ × 2½	18.64	.80	19.44	10	12 × 4	105.85	4.90	110.75	5
* 2½ × 3	18.64	.80	19.44	10	14 × 1	67.50	6.55	74.05	5
3 × 1	8.94	.80	9.74	25	14 × 1½	88.14	6.55	94.69	5
3 × 1½	13.31	.80	14.11	25	14 × 2	90.60	6.55	97.15	5
3 × 2	13.31	.80	14.11	25	14 × 2½	95.94	-	-	5
* 3 × 2½	18.64	1.05	19.69	10	14 × 3	110.74	-	-	5
* 3 × 3	24.95	1.05	26.00	10	14 × 3½	110.74	-	-	5
4 × 1	13.32	1.05	14.37	25	16 × 1	101.71	-	-	5
4 × 1½	14.90	1.05	15.95	25	16 × 1½	101.71	-	-	5
4 × 2	17.21	1.05	18.26	25	16 × 2	110.74	-	-	5
* 4 × 2½	24.62	2.00	26.62	10	16 × 2½	110.74	-	-	5
* 4 × 3	24.62	2.00	26.62	10	18 × 1	114.58	Two-Piece Unsealed		5
5 × 1	17.40	2.00	19.40	10	18 × 1½	114.58			5
5 × 1½	17.63	2.00	19.63	10	18 × 2	128.58			5
5 × 2	17.63	2.00	19.63	10	20 × 1	183.61	Four-Piece Unsealed		3
5 × 2½	27.40	2.00	29.40	10	20 × 2	206.38			3
5 × 3	30.10	2.00	32.10	10	20 × 3	225.33			3
5 × 3½	30.10	2.00	32.10	10	24 × 1½	235.82			3
5 × 4	32.14	2.55	34.69	10	24 × 2	246.30			3
6 × 1	22.98	2.55	25.53	10					
6 × 1½	22.98	2.55	25.53	10					
6 × 2	22.98	2.55	25.53	10					
6 × 2½	34.10	2.55	36.65	10					
6 × 3	38.05	2.55	40.60	10					
6 × 3½	42.11	2.55	44.66	10					
6 × 4	51.00	2.55	53.55	10					
8 × 1	28.36	2.55	30.91	10					
8 × 1½	35.36	2.55	37.91	10					
8 × 2	38.32	2.55	40.87	10					
8 × 2½	45.20	2.55	47.75	10					
8 × 3	54.15	2.55	56.70	5					
8 × 3½	59.15	2.55	61.70	5					
8 × 4	67.50	2.55	70.05	5					
10 × 1	35.70	3.70	39.40	5					
10 × 1½	39.06	3.70	42.76	5					
10 × 2	39.06	3.70	42.76	5					
10 × 2½	59.09	3.70	62.79	5					
10 × 3	69.48	3.70	73.18	5					

Larger sizes available by special order.

Also available unsealed for further savings.

Note: For an insulation thickness of 2" or more use more than one insert as needed.



90° LR Elbow Cover

(*) are provided as an equivalent sized short radius 90° elbow.

90° Short Radius and 45° Sealed Two-Piece Fitting Covers - Color

Size	OD	Without Insert	Insert Price	With Insert	Pcs./ Ctn.
2	1½	\$ 4.79	\$.12	\$ 4.91	100
3	1¾	4.79	.12	4.91	100
4	2½	5.17	.16	5.33	50
5	2¾	5.29	.16	5.45	50
6	2⅝	5.29	.18	5.47	50
7	2⅞	5.29	.18	5.47	50
8	3⅝	6.24	.18	6.42	50
9	3½	6.24	.18	6.42	50
10	4	6.74	.30	7.04	25
11	4½	6.74	.30	7.04	25
12	5	7.56	.30	7.86	25
13	5⅞	7.56	.55	8.11	25
14	6⅝	10.82	.55	11.37	25
15	6⅞	14.28	.55	14.83	25
16	7⅝	14.28	.55	14.83	25
17	7⅞	14.39	.92	15.31	10
18	8⅞	18.64	.92	19.56	10
19	9⅞	18.64	2.24	20.88	10
20	10¾	24.62	2.24	26.86	10
21	11¾	24.62	2.24	26.86	10
22	12¾	30.98	3.90	34.88	5
23	14	30.98	3.90	34.88	5
24	15	38.48	3.90	42.38	5
25	16	41.17	3.90	45.07	5
26	17	53.32	8.70	62.02	5
27	18	53.32	10.11	63.43	5
28	19	79.21	14.90	94.11	5
29	20	79.21	16.50	95.71	5
30	21	79.21	-	-	5

Tee/Valve Covers - Color

Size	OD	Without Insert	Insert Price	With Insert	Pcs./ Ctn.
2	1½	\$ 5.04	\$.11	\$ 5.15	100
3	1¾	5.17	.11	5.28	100
4	2½	5.29	.14	5.43	50
5	2¾	5.61	.14	5.75	50
6	2⅝	5.80	.30	6.10	50
7	2⅞	5.99	.30	6.29	50
8	3⅝	6.11	.30	6.41	50
9	3½	6.25	.30	6.55	50
10	4	6.74	.61	7.35	25
11	4½	7.43	.61	8.04	25
12	5	8.76	.61	9.37	25
13	5⅞	10.77	.65	11.42	25
14	6⅝	14.05	.65	14.70	25
15	6⅞	16.57	.81	17.38	25
16	7⅝	18.65	.81	19.46	25
17	7⅞	25.20	1.60	26.80	10
18	8⅞	28.85	1.60	30.45	10
19	9⅞	31.94	4.20	36.14	10
20	10¾	35.28	4.20	39.48	10
21	11¾	38.81	4.20	43.01	10
22	12¾	42.02	5.64	47.66	5
23	14	48.76	5.64	54.40	5
24	15	55.82	5.64	61.46	5
25	16	58.84	5.64	64.48	5

Note: For an insulation thickness of 2" or more use more than one insert as needed.

See inside front cover for standard colors:

- | | |
|---------------------|---------------------|
| Red 41086-R1 | Light Blue 41073-R1 |
| Orange 41137-R2 | Purple 41932-R1 |
| Yellow 41148-R1 | Tan 42438-R1 |
| Green 41138-R1 | Brown 41079-R2 |
| Dark Gray 14609-E1 | Pea Green 42307-R1 |
| Light Gray 41619-R1 | Black 14587-E1 |
| Dark Blue 14612-E1 | |



45° LR Sealed Elbow Cover

Flange Covers - Color					
Size	OD	Without Insert	Insert Price	With Insert	Pcs./Ctn.
6/7	2 $\frac{1}{8}$ - 2 $\frac{1}{8}$	\$ 7.25	\$.44	\$ 7.69	50
8/9	3 $\frac{1}{8}$ - 3 $\frac{1}{2}$	8.55	.64	9.19	50
10/11	4 - 4 $\frac{1}{2}$	9.05	.94	9.99	25
12/13	5 - 5 $\frac{5}{16}$	10.05	1.12	11.17	25
14/15	6 $\frac{1}{8}$ - 6 $\frac{5}{8}$	13.55	1.43	14.98	10
16/17	7 $\frac{1}{8}$ - 7 $\frac{5}{8}$	19.55	2.08	21.63	10
18/19	8 $\frac{5}{8}$ - 9 $\frac{5}{8}$	22.60	2.54	25.14	10
20/21	10 $\frac{3}{4}$ - 11 $\frac{3}{4}$	29.15	3.12	32.27	10
22/23	12 $\frac{3}{4}$ - 14	37.45	3.71	41.16	10
24/25	15 - 16	38.35	4.31	42.66	10

Note: For an insulation thickness of 2" or more use more than one insert as needed.



Flange Coupling Cover

Union Covers - Color			
Size	OD	List Price	Pcs./Ctn.
7	2 $\frac{1}{8}$	\$ 4.29	Packaged to order
9	3 $\frac{1}{2}$	5.01	
10	4	5.23	
11	4 $\frac{1}{2}$	6.88	
12	5	7.32	
13	5 $\frac{5}{16}$	7.43	
15	6 $\frac{5}{8}$	12.16	



Union Cover

Y-Strainer - Color			
Size	OD	List Price	Pcs./Ctn.
7	2 $\frac{1}{8}$	\$ 8.24	Packaged to order
9	3 $\frac{1}{2}$	14.58	
10	4	19.48	
11	4 $\frac{1}{2}$	20.31	
12	5	20.67	
13	5 $\frac{5}{16}$	28.67	
14	6 $\frac{1}{8}$	29.99	
15	6 $\frac{5}{8}$	30.85	
17	7 $\frac{5}{8}$	41.97	
18	8 $\frac{5}{8}$	44.02	
19	9 $\frac{5}{8}$	49.68	
20	10 $\frac{3}{4}$	50.71	
21	11 $\frac{3}{4}$	54.23	
22	12 $\frac{3}{4}$	58.83	



Y-Strainer/Lateral Cover

25/50 Smoke-Safe™ PVC

pvc fitting covers
color list prices

Oval (Adjustable) End Caps have a cross scribe line for field cutting; this cut allows an overlapping of two halves for a neat circumferential cap. The Oval End Caps also have circular scribe lines providing a quick easy guide to cutting out the cap's inside to produce a simple reducer. The Round End Caps are a neat circular cap of an outside diameter of standard pipe insulation dimensions.



Oval End Cap

Inline Reducers are concentric reducers providing an easy, very neat reduction from one insulation outside diameter to another. They are formed as full round bodies with generous full extensions.



Reducer

End Caps - Color				Standard Oval/Round			
Size	OD	List Price	Pcs./Ctn.	Size	OD	List Price	Pcs./Ctn.
2	1½"	\$ 1.13	100	25	16"	\$ 14.62	15
3	1¾"	1.13	100	26	17"	20.10	t/o
4	2"	1.13	50	27	18"	21.04	t/o
5	2¼"	1.18	50	28	19"	24.76	t/o
6	2½"	1.32	50	29	20"	28.16	t/o
7	2¾"	1.39	50	30	21"	33.53	t/o
8	3"	1.45	50	31	22"	37.23	t/o
9	3½"	1.51	50	32	23"	38.30	t/o
10	4"	1.64	50	33	24"	41.23	t/o
11	4½"	1.83	50	34	25"	43.46	t/o
12	5"	2.08	50	35	26"	43.96	t/o
13	5½"	2.39	50	36	27"	44.15	t/o
14	6"	2.52	50	37	28"	44.15	t/o
15	6½"	2.71	50	38	29"	45.20	t/o
16	7"	4.79	50	39	30"	45.20	t/o
17	7½"	5.73	50	40	31"	46.10	t/o
18	8"	6.36	50	41	32"	46.10	t/o
19	9"	7.69	15	42	33"	46.50	t/o
20	10¼"	8.19	15	43	34"	47.10	t/o
21	11¼"	8.76	15	44	35"	47.35	t/o
22	12¼"	9.64	15	45	36"	48.10	t/o
23	14"	12.92	15	46	37"	48.60	t/o
24	15"	14.11	15	47	38"	49.00	t/o

Inline Reducers - Color			
Larger P/C OD	List Price	Larger P/C OD	List Price
2¾"	\$ 2.22	19"	\$ 24.17
2¾"	2.29	20"	25.45
3½"	2.37	21"	26.82
4"	2.65	22"	28.74
4½"	2.94	23"	29.54
5"	3.43	24"	29.54
5½"	3.86	25"	32.18
6"	4.22	26"	33.97
7"	6.29	27"	35.26
8"	6.44	28"	36.69
9"	7.01	29"	39.75
10¼"	7.37	30"	41.12
11¼"	8.09	31"	44.26
12¼"	9.15	32"	46.48
14"	15.09	33"	49.19
15"	15.66	34"	51.48
16"	17.73	35"	54.27
17"	19.67	36"	57.20
18"	21.45		

Note: Reducers are packaged to order. Price covers by the larger OD and state the required reduced size when ordering. An example 8" OD (@ \$6.44) reduced to 6". Covers are provided without inserts.

Note: Shaded sizes are available in **Round End Caps** only and packaged to order.

See inside front cover for standard colors

Victaulic® Coupling Cover - Color				
Size	Without Insert	Insert Price	With Insert	Pcs./ Ctn.
11	\$ 6.50	\$.52	\$ 7.02	25
12	6.79	.55	7.34	25
13	8.48	.63	9.11	25
15	9.06	.74	9.80	10
17	11.28	.95	12.23	10
18	14.53	1.13	15.66	10
19	25.07	1.58	26.65	10
20	26.59	1.65	28.24	10
21	32.62	2.02	34.64	10
22/23	32.83	2.41	35.24	10
24/25	39.90	2.41	42.31	10
26	42.50	3.39	48.79	10

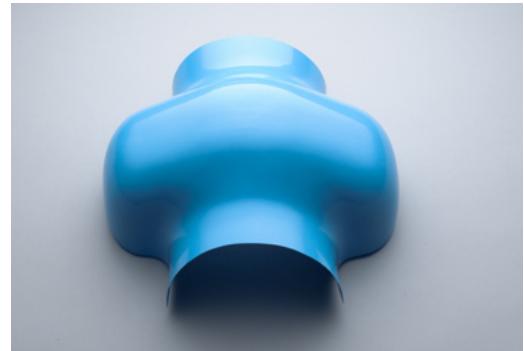

Victaulic® Coupling Cover

Larger size Victaulic® Type Coupling Covers will accommodate two different outside diameters.

Sizing Chart for Use of Low Profile Victaulic® Fitting Covers on Victaulic® Copper Tubing Fittings

Tube Size	Type	Insulation Thickness				
		½"	¾"	1"	1½"	2"
2½	90°	2 × ½	2½ × ½	2½ × ½	2½ × 1	2 × 2
	45°	2 × ½	2½ × ½	2½ × ½	2½ × 1	2½ × 1½
	Tee	2 × ½	2½ × ½	2½ × ½	2½ × 1	2 × 2
2¾	90°	2½ × ½	2 × 1	2 × 1	2 × 1½	2 × 2
	45°	2½ × ½	3 × ½	3 × ½	3 × 1	3 × 1½
	Tee	2½ × ½	2 × 1	2 × 1	2 × 1½	2 × 2
3½	90°	3 × ½	2½ × 1	2½ × 1	2½ × 1½	2½ × 2
	45°	3 × ½	2½ × 1	2½ × 1	3 × 1½	3 × 2
	Tee	2½ × 1	2½ × 1	2½ × 1	2½ × 1½	2½ × 2
4½	90°	4 × ½		4 × 1	4 × 1½	4 × 2
	45°	4 × ½		4 × 1	4 × 1½	4 × 2
	Tee	3 × 1		3 × 1½	3 × 2	4 × 2
5½	90°	5 × ½		5 × 1	5 × 1½	5 × 2
	45°	5 × ½		5 × 1	5 × 1½	5 × 2
	Tee	5 × ½		5 × 1	5 × 1½	5 × 2
6½	90°	6 × ½		6 × 1	6 × 1½	6 × 2
	45°	6 × ½		6 × 1	6 × 1½	6 × 2
	Tee	6 × ½		6 × 1	6 × 1½	6 × 2

Each specific size should be cut off at the noted outside diameter to provide a proper fit.

Low Profile Victaulic® Fitting Covers - Color

Each Victaulic® Type Fitting Cover has stepped outer laps for neatly overlapping a ½", 1", 1½" or 2" pipe insulation thickness for the pipe sizes shown (10" Covers and larger do not have a ½" lap). Additional outer diameters are provided on 4" and larger Covers. Example: 14 × 1 through 14 × 4, all in one fitting cover (see pages 8 and 9 for all sizes and installation details).

Note: For an insulation thickness of 2" or more, use more than one insert as needed.

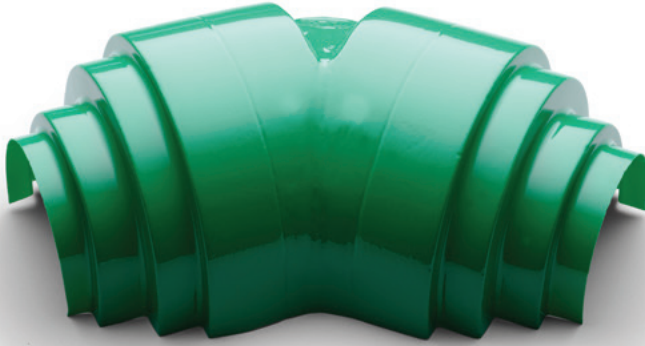

45° Low Profile Victaulic® Cover

Standard Colors

The colors shown here are all standard colors and are available in all Speedline® PVC fitting cover sizes, types and all jacketing. Colors are made-to-order and price separately. Please consult your sales rep for more information. All colored fitting covers and jacketing have a high Gloss finish.



Colors from Left to right:

White, Black, Brown, Tan, Yellow, Red, Orange, Purple, Green, Pea Green, Dark Grey, Light Grey, Dark Blue, Light Blue. Please consult your sales rep on custom colors.

90° Low Profile Victaulic® Elbow Covers (2 Pc.) - Color

Size (in.)	Without Insert	Insert Price	With Insert	Pcs./ Ctn.
2	\$ 8.91	\$.64	\$ 9.55	10
2½	9.49	.64	10.13	10
3	11.64	1.06	12.70	10
4	14.17	1.63	15.80	10
5	16.51	2.26	18.77	10
6	21.65	2.55	24.20	5
8	28.80	2.55	31.35	5
10	39.26	3.70	42.96	5
12	69.22	5.18	74.40	5
14	71.18	-	-	5

45° Low Profile Victaulic® Elbow Covers (2 Pc.) - Color

Size (in.)	Without Insert	Insert Price	With Insert	Pcs./ Ctn.
2	\$ 8.78	\$.64	\$ 9.42	10
2½	8.97	.64	9.61	10
3	11.64	1.06	12.70	10
4	14.17	1.63	15.80	10
5	16.51	2.26	18.77	10
6	21.32	2.55	23.87	5
8	28.21	2.55	30.76	5
10	36.14	3.70	39.84	5
12	58.63	5.18	63.81	5
14	61.75	-	-	5

Low Profile Victaulic® Tee Covers (2 Pc.) - Color

Size (in.)	Without Insert	Insert Price	With Insert	Pcs./ Ctn.
2	\$ 16.50	\$.83	\$ 17.33	5
2½	17.75	.83	18.58	5
3	20.60	1.04	21.64	5
4	29.50	1.75	31.25	5
5	34.60	1.75	36.35	5
6	41.20	3.42	44.62	5
8	49.60	4.20	53.80	5
10	62.60	5.64	68.24	5
12	82.35	5.64	87.99	5
14	84.70	-	-	5

Original Victaulic® Fitting Covers - Color

90° and 45° Victaulic® Type Elbow Covers are made in two half sections which are available sealed as a one piece cover (for ease of installation).

Each Fitting Cover has stepped outer laps for neatly overlapping a ½", 1", 1½" or 2" pipe insulation thickness for the pipe sizes shown

(see picture below for cutoff steps).

Note: For an insulation thickness of 2" or more use more than one insert as needed.

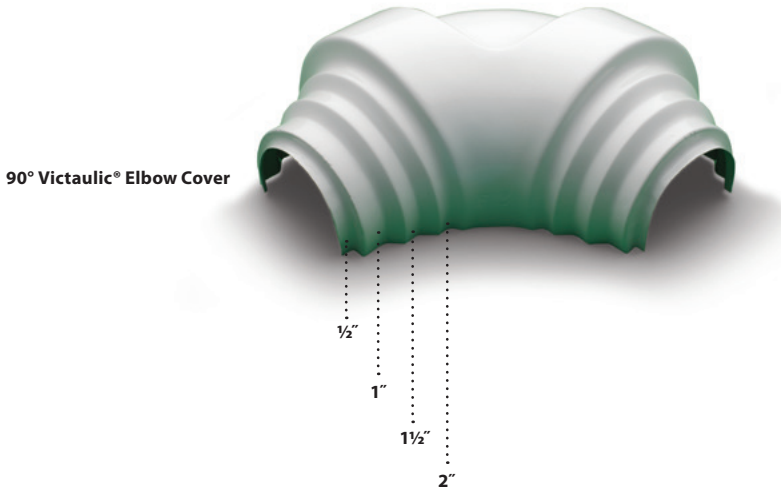

90° Victaulic® Elbow Cover



45° Victaulic® Elbow Cover

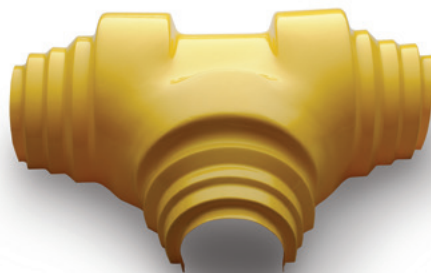

Victaulic® Tee Cover

For Victaulic® Type Coupling Covers see page 28.

See inside front cover for standard colors

90° Victaulic® Elbow Covers Original Sealed - Color

Size (in.)	Without Insert	Insert Price	With Insert	Pcs./ Ctn.
2	\$ 14.70	\$.64	\$ 15.34	3
2½	15.68	.64	16.32	3
3	20.06	1.06	21.12	3
4	21.52	1.63	23.15	3
5	31.36	2.26	33.62	3
6	37.27	2.55	39.82	3
8	44.10	2.55	46.65	3
10	52.98	3.70	56.68	3
12	74.54	5.18	79.72	3
14	75.70 *	-	-	-

* Not sealed

45° Victaulic® Elbow Covers Original Sealed - Color

Size (in.)	Without Insert	Insert Price	With Insert	Pcs./ Ctn.
2	\$ 12.88	\$.64	\$ 13.52	5
2½	14.14	.64	14.78	5
3	19.11	1.06	20.17	5
4	19.74	1.63	21.37	5
5	26.95	2.26	29.21	5
6	34.79	2.55	37.34	5
8	37.87	2.55	40.42	5
10	45.15	3.70	48.85	5
12	63.14	5.18	68.32	5
14	65.50 *	-	-	5

* Not sealed

Victaulic® Tee Covers Original (Unsealed 2 Pc.) - Color

Size (in.)	Without Insert	Insert Price	With Insert	Pcs./ Ctn.
2	\$ 16.50	\$.83	\$17.33	5
2½	17.75	.83	\$18.58	5
3	20.60	1.04	\$21.64	5
4	29.50	1.75	\$31.25	5
5	34.60	1.75	\$36.35	5
6	41.20	3.42	\$44.62	5
8	49.60	3.42	\$53.80	5
10	62.60	5.64	\$68.24	5
12	82.35	5.64	\$87.99	5
14	84.70	-	-	5

Heavy Duty Sealed Two-Piece 90° Short Radius and 45° Covers - White

Size	OD	Without Insert	Insert Price	With Insert	Pcs./ Ctn.
2	1½	\$ 2.70	\$.12	\$ 2.82	100
3	1¾	2.80	.12	2.92	100
4	2½	3.00	.16	3.16	50
5	2¾	3.15	.16	3.31	50
6	2¾	3.25	.18	3.43	50
7	2¾	3.45	.18	3.63	50
8	3¾	4.65	.18	4.83	50
9	3½	4.80	.18	4.98	50
10	4	5.40	.30	5.70	25
11	4½	5.90	.30	6.20	25
12	5	7.15	.30	7.45	25
13	5¾	7.80	.55	8.35	25
14	6¾	10.30	.55	10.85	25
15	6¾	11.50	.55	12.05	25
16	7¾	12.00	.55	12.55	25
17	7¾	12.00	.92	12.92	10
18	8¾	17.05	.92	17.97	10
19	9¾	17.10	2.24	19.34	10
20	10¾	23.90	2.24	26.14	10
21	11¾	24.45	2.24	26.69	10
22	12¾	24.75	3.90	28.65	5
23	14	27.25	3.90	31.15	5
24	15	34.05	3.90	37.95	5
25	16	36.90	3.90	40.80	5
26	17	45.85	8.70	54.55	5
27	18	53.90	10.11	64.01	5
28	19	69.30	14.90	84.20	5
29	20	79.90	16.50	96.40	5
30	21	89.45	-	-	5

Heavy Duty Tee/Valve Covers - White

Size	OD	Without Insert	Insert Price	With Insert	Pcs./ Ctn.
2	1½	\$ 4.20	\$.11	\$ 4.31	100
3	1¾	4.31	.11	4.42	100
4	2½	4.41	.14	4.55	50
5	2¾	4.67	.14	4.81	50
6	2¾	4.83	.30	5.13	50
7	2¾	4.99	.30	5.29	50
8	3¾	5.09	.30	5.39	50
9	3½	5.21	.30	5.51	50
10	4	5.62	.61	6.23	25
11	4½	6.20	.61	6.81	25
12	5	7.30	.61	7.91	25
13	5¾	8.98	.65	9.63	25
14	6¾	11.71	.65	12.36	25
15	6¾	13.81	.81	14.62	25
16	7¾	15.54	.81	16.35	25
17	7¾	21.00	1.60	22.60	10
18	8¾	24.05	1.60	25.65	10
19	9¾	26.62	4.20	30.82	10
20	10¾	29.40	4.20	33.60	10
21	11¾	32.34	4.20	36.54	10
22	12¾	35.02	5.64	40.66	5
23	14	40.64	5.64	46.28	5
24	15	46.52	5.64	52.16	5
25	16	49.04	5.64	54.68	5

Note: For an insulation thickness of 2" or more, use more than one insert as needed.

Extra heavy gauge Heavy Duty Fitting Covers are available upon request.

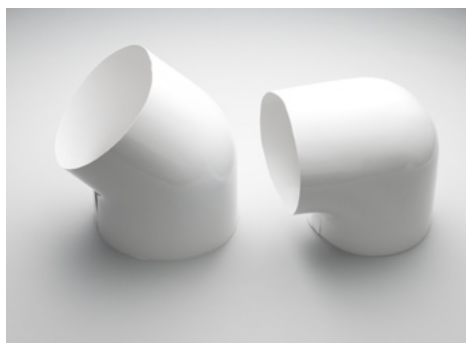

Heavy Duty 90° and 45° Elbow Covers



Heavy Duty Tee Cover

90° LR Heavy Duty Sealed Two-Piece Fitting Covers - White

Size	Without Insert	Insert Price	With Insert	Pcs./Ctn.	Size	Without Insert	Insert Price	With Insert	Pcs./Ctn.
1½ × 1	\$ 3.80	\$.30	\$ 4.10	25	8 × 1	\$ 23.85	\$ 2.55	\$ 26.40	10
1½ × 1½	4.75	.30	5.05	25	8 × 1½	34.33	2.55	44.30	10
2 × 1	5.90	.45	6.35	25	8 × 2	37.25	2.55	39.80	10
2 × 1½	9.10	.45	9.55	25	8 × 2½	38.85	2.55	41.40	10
* 2 × 2½	11.15	.45	11.60	10	8 × 3	49.75	2.55	52.30	5
* 2 × 3	14.00	.45	14.45	10	8 × 3½	52.90	2.55	55.45	5
2½ × 1	7.40	.60	8.00	25	8 × 4	63.70	2.55	66.25	5
2½ × 1½	9.45	.60	10.05	25	10 × 1	33.80	3.70	37.50	5
* 2½ × 2½	12.65	.60	13.25	10	10 × 1½	42.35	3.70	46.05	5
* 2½ × 3	17.05	.60	17.65	10	10 × 2	46.75	3.70	50.45	5
3 × 1	7.70	.80	8.50	25	10 × 2½	53.00	3.70	56.70	5
3 × 1½	10.90	.80	11.70	25	10 × 3	64.75	3.70	68.45	5
3 × 2	10.95	.80	11.25	25	10 × 3½	64.90	3.70	68.60	5
* 3 × 2½	17.10	.80	17.90	10	10 × 4	85.80	3.70	89.50	5
* 3 × 3	19.10	.80	19.90	10	12 × 1	48.00	4.90	52.90	5
4 × 1	10.95	1.05	12.00	25	12 × 1½	52.45	4.90	57.35	5
4 × 1½	11.50	1.05	12.55	25	12 × 2	58.85	4.90	63.75	5
4 × 2	15.05	1.05	16.10	25	12 × 2½	65.25	4.90	70.15	5
* 4 × 2½	20.65	1.05	21.70	10	12 × 3	78.00	4.90	82.90	5
* 4 × 3	22.65	1.05	23.70	10	12 × 3½	94.20	4.90	99.10	5
5 × 1	14.35	2.00	16.35	10	12 × 4	98.00	4.90	102.90	5
5 × 1½	16.50	2.00	18.50	10	14 × 1	64.10	6.10	70.20	5
5 × 2	18.00	2.00	20.00	10	14 × 1½	73.40	7.25	80.65	5
5 × 2½	23.90	2.00	25.90	10	14 × 2	74.20	8.30	82.50	5
5 × 3	26.90	2.00	28.90	10	14 × 2½	90.80	9.50	100.30	5
5 × 3½	26.90	2.00	28.90	10	14 × 3	101.75	11.20	112.95	5
5 × 4	28.10	2.55	30.65	10	14 × 3½	105.00	-	-	5
6 × 1	19.00	2.55	21.55	10	16 × 1	88.80	-	-	5
6 × 1½	20.20	2.55	22.75	10	16 × 1½	88.80	-	-	5
6 × 2	20.60	2.55	23.15	10	16 × 2	101.75	-	-	5
6 × 2½	27.10	2.55	29.65	10	16 × 2½	101.90	-	-	5
6 × 3	35.10	2.55	37.65	10	18 × 1	108.10	-	-	5
6 × 3½	37.50	2.55	40.05	10	18 × 1½	108.10	-	-	5
6 × 4	48.75	2.55	51.30	10	18 × 2	124.05	-	-	5

(*) Items are furnished as the equivalent numbered SR Elbow Cover.

Sizes in shaded area are two-piece/unsealed only.

Extra heavy gauge Heavy Duty Fitting Covers are available upon request.

Note: For an insulation thickness of 2" or more, use more than one insert as needed.



90° Heavy Duty Elbow Cover shown in green. Standard color is white.

Flange Covers Heavy Duty - White					
Size	OD	Without Insert	Insert Price	With Insert	Pcs./Ctn.
6/7	2 $\frac{1}{8}$ - 2 $\frac{1}{8}$	\$ 8.33	\$.44	\$ 8.77	50
8/9	3 $\frac{1}{8}$ - 3 $\frac{1}{2}$	9.89	.64	10.53	50
10/11	4 - 4 $\frac{1}{2}$	10.43	.94	11.37	25
12/13	5 - 5 $\frac{1}{16}$	14.36	1.12	15.48	25
14/15	6 $\frac{1}{8}$ - 6 $\frac{1}{8}$	15.65	1.43	17.08	10
16/17	7 $\frac{1}{8}$ - 7 $\frac{1}{8}$	22.56	2.08	24.64	10
18/19	8 $\frac{1}{8}$ - 9 $\frac{1}{8}$	26.12	2.54	28.66	10
20/21	10 $\frac{3}{4}$ - 11 $\frac{3}{4}$	33.63	3.12	36.75	10
22/23	12 $\frac{3}{4}$ - 14	43.23	3.71	46.94	10
24/25	15 - 16	44.25	4.31	48.56	10

Note: For an insulation thickness of 2" or more use more than one insert as needed.



Heavy Duty Flange Coupling Cover

Union Covers Heavy Duty - White				
Size	OD	List Price	Pcs./Ctn.	
7	2 $\frac{1}{8}$	\$ 4.50	Packaged to order	
9	3 $\frac{1}{2}$	5.25		
10	4	5.48		
11	4 $\frac{1}{2}$	7.20		
12	5	7.65		
13	5 $\frac{1}{16}$	7.80		
15	6 $\frac{1}{8}$	12.75		



Heavy Duty Union Cover shown in blue. Standard color is white.

Y-Strainer Heavy Duty - White				
Size	OD	List Price	Pcs./Ctn.	
7	2 $\frac{1}{8}$	\$ 8.25	Packaged to order	
9	3 $\frac{1}{2}$	8.48		
10	4	19.50		
11	4 $\frac{1}{2}$	19.50		
12	5	19.58		
13	5 $\frac{1}{16}$	27.00		
14	6 $\frac{1}{8}$	30.00		
15	6 $\frac{1}{8}$	30.00		
17	7 $\frac{1}{8}$	42.00		
18	8 $\frac{1}{8}$	42.00		
19	9 $\frac{1}{8}$	45.00		
20	10 $\frac{3}{4}$	45.00		
21	11 $\frac{3}{4}$	45.00		
22	12 $\frac{3}{4}$	45.00		



Heavy Duty Y-Strainer/Lateral Cover shown in red. Standard color is white.

25/50 Smoke-Safe™ PVC

pvc fitting covers
heavy duty list prices



Heavy Duty Round End Cap shown in standard color of white.

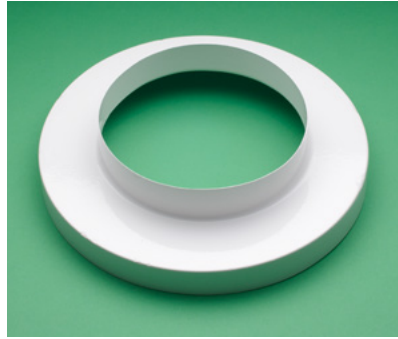

Heavy Duty Reducer shown in standard color of white.

Inline Reducers are concentric reducers providing an easy, very neat reduction from one insulation outside diameter to another. They are formed as full round bodies with generous full extensions.

Heavy Duty End Caps, Round - White			
Size	OD	List Price	Pcs./ Ctn.
2	1½	\$.30	100
3	1¾	.35	100
4	2½	.39	50
5	2¾	.47	50
6	2½	.68	50
7	2¾	.71	50
8	3½	.98	50
9	3½	1.10	50
10	4	1.10	50
11	4½	1.25	50
12	5	1.37	50
13	5½	1.83	50
14	6½	2.40	50
15	6½	3.18	50
16	7½	3.75	50
17	7½	4.43	50
18	8½	4.91	50
19	9½	5.90	15
20	10¾	6.42	15
21	11¾	7.28	15
22	12¾	8.04	15
23	14	11.18	15
24	15	11.76	15

Heavy Duty Inline Reducers - White			
Larger P/C OD	List Price	Larger P/C OD	List Price
25	16	\$ 12.21	15
26	17	16.88	t/o
27	18	19.50	t/o
28	19	22.88	t/o
29	20	24.98	t/o
30	21	32.70	t/o
31	22	36.30	t/o
32	23	37.35	t/o
33	24	40.20	t/o
34	25	42.38	t/o
35	26	43.25	t/o
36	27	44.13	t/o
37	28	45.03	t/o
38	29	45.96	t/o
39	30	46.91	t/o
40	31	49.88	t/o
41	32	51.90	t/o
42	33	53.25	t/o
43	34	54.68	t/o
44	35	56.40	t/o
45	36	57.75	t/o
46	37	59.03	t/o
47	38	60.38	t/o

Note: Reducers are packaged to order. Price covers by the larger OD and state the required reduced size when ordering. An example 8½" OD (@ \$6.75) reduced to 6½". Covers are provided without inserts.

PVC Fittings and Cut & Curl Jacketing - Quick Reference Sizing Charts

The following composite charts are based on the PVC Fitting Cover Sizing Charts on page 10 and the PVC Jacketing Sizing Charts on page 19.

These quick reference charts list each PVC fitting size in bold and its corresponding Cut & Curl Jacketing size in parentheses to the right.

Iron Pipe (Combining Chart A on p. 10 with Chart D on p. 19)								
Pipe Size	Insulation Thickness (in.)							
	½	1	1½	2	2½	3	3½	4
¾	2 (-)	7 (3.0)	9 (3.5)					
½	3 (2.0)	7 (3.0)	10 (4.0)	12 (5.0)	15 (6.5)	17 (7.5)	18 (8.5)	19 (9.5)
¾	5 (2.5)	7 (3.0)	10 (4.0)	12 (5.0)	15 (6.5)	17 (7.5)	18 (8.5)	19 (9.5)
1	5 (2.5)	9 (3.5)	11 (4.5)	13 (5.5)	15 (6.5)	17 (7.5)	18 (8.5)	19 (9.5)
1¼	7 (3.0)	9 (3.5)	12 (5.0)	13 (5.5)	15 (6.5)	17 (7.5)	18 (8.5)	19 (9.5)
1½	7 (3.0)	10 (4.0)	12 (5.0)	15 (6.5)	17 (7.5)	18 (8.5)	19 (9.5)	20 (10.5)
2	9 (3.5)	11 (4.5)	13 (5.5)	15 (6.5)	17 (7.5)	18 (8.5)	19 (9.5)	20 (10.5)
2½	10 (4.0)	12 (5.0)	15 (6.5)	17 (7.5)	18 (8.5)	19 (9.5)	20 (10.5)	21 (11.5)
3	11 (4.5)	13 (5.5)	15 (6.5)	17 (7.5)	18 (8.5)	19 (9.5)	20 (10.5)	21 (11.5)
3½	12 (5.0)	15 (6.5)	17 (7.5)	18 (8.5)	19 (9.5)	20 (10.5)	21 (11.5)	22 (12.5)
4	13 (5.5)	15 (6.5)	17 (7.5)	18 (8.5)	19 (9.5)	20 (10.5)	21 (11.5)	22 (12.5)
5	15 (6.5)	17 (7.5)	18 (8.5)	19 (9.5)	20 (10.5)	21 (11.5)	22 (12.5)	23 (14.0)
6	17 (7.5)	18 (8.5)	19 (9.5)	20 (10.5)	21 (11.5)	22 (12.5)	23 (14.0)	24 (15.0)
8	19 (9.5)	20 (10.5)	21 (11.5)	22 (12.5)	23 (14.0)	24 (15.0)	25 (15.0)	26 (17.0)
10	21 (11.5)	22 (12.5)	23 (14.0)	24 (15.0)	25 (15.0)	26 (17.0)	27 (18.0)	28 (19.0)
12		24 (15.0)	25 (16.0)	26 (17.0)	27 (18.0)	28 (19.0)	29 (20.0)	30 (21.0)
14		25 (16.0)	26 (17.0)	27 (18.0)	28 (19.0)	29 (20.0)	30 (21.0)	31 (22.0)
16		27 (18.0)	28 (19.0)	29 (20.0)	30 (21.0)	31 (22.0)	32 (23.0)	33 (24.0)
18		29 (20.0)	30 (21.0)	31 (22.0)	32 (23.0)	33 (24.0)	34 (25.0)	35 (26.0)
20		31 (22.0)	32 (23.0)	33 (24.0)	34 (25.0)	35 (26.0)	36 (27.0)	37 (28.0)

Note: Those 90° Long Radius Elbow sizes falling within the shaded areas of Chart A (on page 10) require special specific sizes (pipe size × insulation thickness). Generic/short radius sizes can be substituted for long radius sizes for unshaded sizes of Chart A (on page 10).

Copper Tubing (Combining Chart B on p. 10 with Chart E on p. 19)									
Tube Size	OD	Insulation Thickness (in.)							
		½	1	1½	2	2½	3	3½	4
¾	½		5 (2.5)	9 (3.5)	11 (4.5)	13 (5.5)	15 (6.5)		
½	¾	3 (2.0)	7 (3.0)	9 (3.5)	11 (4.5)	13 (5.5)	15 (6.5)		
¾	7/8	3 (2.0)	7 (3.0)	10 (4.0)	12 (5.0)	15 (6.5)	17 (7.5)	18 (8.5)	19 (9.5)
1	1½	5 (2.5)	7 (3.0)	10 (4.0)	12 (5.0)	15 (6.5)	17 (7.5)	18 (8.5)	19 (9.5)
1¼	1¾	5 (2.5)	9 (3.5)	11 (4.0)	13 (5.5)	15 (6.5)	17 (7.5)	18 (8.5)	19 (9.5)
1½	1¾	7 (3.0)	9 (3.5)	12 (5.0)	13 (5.5)	15 (6.5)	17 (7.5)	18 (8.5)	19 (9.5)
2	2½	9 (3.5)	10 (4.0)	12 (5.0)	15 (6.5)	17 (7.5)	18 (8.5)	19 (9.5)	20 (10.5)
2½	2¾	10 (4.0)	11 (4.5)	13 (5.5)	15 (6.5)	17 (7.5)	18 (8.5)	19 (9.5)	20 (10.5)
3	3¾	11 (4.5)	12 (5.0)	15 (6.5)	17 (7.5)	18 (8.5)	19 (9.5)	20 (10.5)	21 (11.5)
3½	3¾	11 (4.5)	13 (5.5)	15 (6.5)	17 (7.5)	18 (8.5)	19 (9.5)	20 (10.5)	21 (11.5)
4	4¾	13 (5.5)	15 (6.5)	17 (7.5)	18 (8.5)	19 (9.5)	20 (10.5)	21 (11.5)	22 (12.5)
5	5¾	15 (6.5)	17 (7.5)	18 (8.5)	19 (9.5)	20 (10.5)	21 (11.5)	22 (12.5)	23 (14.0)
6	6¾	17 (7.5)	18 (8.5)	19 (9.5)	20 (10.5)	21 (11.5)	22 (12.5)	23 (14.0)	24 (15.0)

Piping Dimensional Data

Iron Pipe Size	Outside Diameter of Pipe (inches)	Standard Short Radius 90° Screwed Elbow	Standard 45° Screwed Elbow	Standard Screwed Tee	Welding Short Radius 90° Elbow	Welding Long Radius 90° Elbow	Welding 45° Elbow
		"A" Dim.	"A" Dim.	"A" Dim.	"A" Dim.	"A" Dim.	"A" Dim.
3/8	.675	15/16	13/16	15/16			
1/2	.840	1 1/8	7/8	1 1/8		1 1/2	
3/4	1.050	1 5/16	1	1 5/16		1 1/8	9/16
1	1.315	1 1/2	1 1/8	1 1/2	1	1 1/2	7/8
1 1/4	1.660	1 3/4	1 5/16	1 3/4	1 1/4	1 7/8	1
1 1/2	1.900	1 15/16	1 7/16	1 15/16	1 1/2	2 1/4	1 1/8
2	2.375	2 1/4	1 11/16	2 1/4	2	3	1 3/8
2 1/2	2.875	2 1/16	1 15/16	2 1/16	2 1/2	3 3/4	1 3/4
3	3.500	3 1/16	2 3/16	3 1/16	3	4 1/2	2
3 1/2	4.000	3 7/16	2 7/16	3 7/16	3 1/2	5 1/4	2 1/4
4	4.500	3 13/16	2 5/8	3 13/16	4	6	2 1/2
5	5.563	4 1/2	3 1/16	4 1/2	5	7 1/2	3 3/8
6	6.625	5 1/8	3 7/16	5 1/8	6	9	3 3/4
8	8.625	6 9/16	4	6 9/16	8	12	5
10	10.750				10	15	6 1/4
12	12.750				12	18	7 1/2
14	14				14	21	8 3/4
16	16				16	24	10
18	18				18	27	11 1/4
20	20				20	30	12 1/2
22	22				22	33	13 1/2
24	24				24	36	

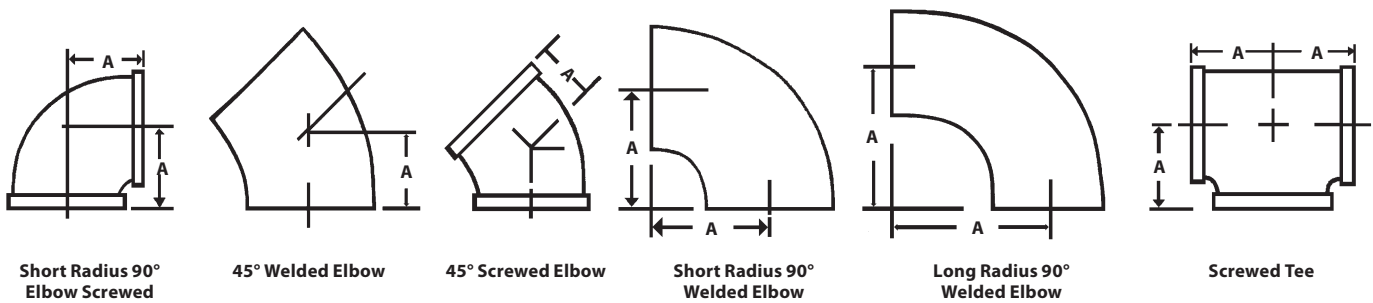

Piping Dimensional Data

Iron Pipe Size	Welding Tee "A" Dim.	Victaulic® 90° Elbow "A" Dim.	Victaulic® 45° Elbow "A" Dim.	Victaulic® Tee Style 77 "A" Dim.	Victaulic® Coupling "A" "B"		Steel Flange (welded/threaded/blind/etc.)			
							150#		300/400#	
							"A"	"B"	"A"	"B"
3/8										
1/2							3 1/2	7/16	3 3/4	9/16
3/4	1 1/8	2 1/4	1 1/2	2 1/4	3 5/8	1 3/4	3 7/8	1/2	4 5/8	5/8
1	1 1/2	2 1/4	1 3/4	2 1/4	3 7/8	1 7/8	4 1/4	9/16	4 7/8	1 1/16
1 1/4	1 7/8	2 3/4	1 3/4	2 3/4	4 5/8	1 7/8	4 5/8	5/8	5 1/4	1 3/16
1 1/2	2 1/4	2 3/4	1 3/4	2 3/4	5	1 7/8	5	1 1/16	6 1/8	7/8
2	2 1/2	3 1/4	2	3 1/4	5 5/8	1 7/8	6	3/4	6 1/2	1
2 1/2	3	3 3/4	2 1/4	3 3/4	6 1/4	1 7/8	7	7/8	7 1/2	1 1/8
3	3 3/8	4 1/4	2 1/2	4 1/4	7	1 7/8	7 1/2	1 5/16	8 1/4	1 1/4
3 1/2	3 3/4	4 1/2	2 3/4	4 1/2	8	1 1/16	8 1/2	1 5/16	9	1 3/8
4	4 1/8	5	3	5	8 1/2	1 1/16	9	1 5/16	10	1 3/8
5	4 7/8	5 1/2	3 1/4	5 1/2	10 1/4	1 1/16	10	1 5/16	11	1 1/2
6	5 5/8	6 1/2	3 1/2	6 1/2	11 1/2	1 1/16	11	1	12 1/2	1 5/8
8	7	7 3/4	4 1/4	7 3/4	14 1/2	2 1/2	13 1/2	1 1/8	15	1 7/8
10	8 1/2	9	4 3/4	9	16 3/4	2 9/16	16	1 3/16	17 1/2	2 1/8
12	10	10	5 1/4	10	19	2 9/16	19	1 1/4	20 1/2	2 1/4
14	11	21	8 3/4	11	20	2 15/16	21	1 3/8	23	2 3/8
16	12	24	10	12	22 3/8	2 15/16	23 1/2	1 7/16	25 1/2	2 1/2
18	13 1/2	27	11 1/4	15 1/2	24 3/8	3 1/16	25	1 9/16	28	2 5/8
20	15	30	12 1/2	17 1/4	27 1/2	3 1/16	27 1/2	1 11/16	30 1/2	2 3/4
22	16 1/2	-	-	-	30	3 1/8	29 1/2	1 13/16	33	2 7/8
24	17	36	15	20	31 3/8	3 1/8	32	1 7/8	36	3

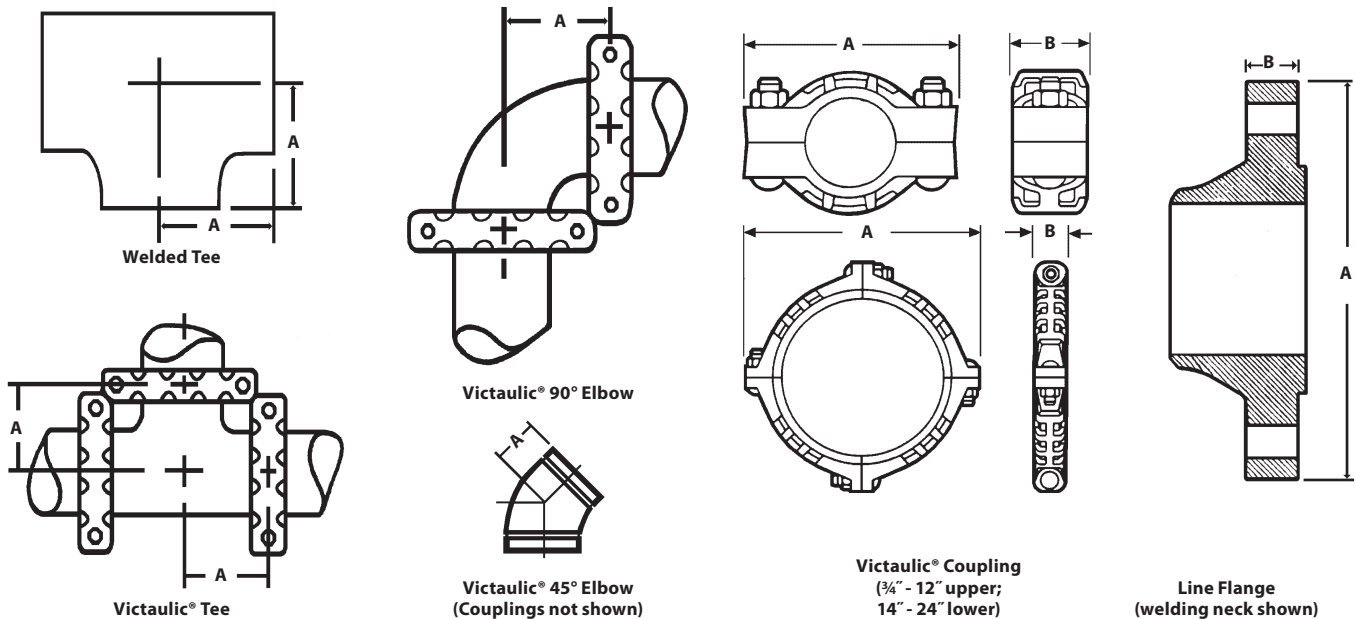

Product Index

45° Fitting Cover – White	11	Inline Reducer Cover – Color	27
45° Fitting Cover – Color	25	Inline Reducer Cover – Heavy Duty	35
45° Fitting Cover – Heavy Duty	31	P–Trap Covering System – White ..	23
90° Long Radius Fitting Cover – White	12	P–Trap Full Profile Covers – PVC ..	18
90° Long Radius Fitting Cover – Color	24	PVC Corner Angle	22
90° Long Radius Fitting Cover – Heavy Duty	32	PVC Rod Cover	22
90° Short Radius Fitting Cover – White	11	Roll Jacketing – White, Color & Jumbo	20
90° Short Radius Fitting Cover – Color	25	Roof Drain/Sump Cover – White ..	14
90° Short Radius Fitting Cover – Heavy Duty	31	Stainless Steel Tack Fasteners	21
90° Humped One Piece Short Radius Fitting Cover	18	Tee/Valve Cover – White	11
Adhesive – Solvent Weld	22	Tee/Valve Cover – Color	25
Adhesive Dispenser	22	Tee/Valve Cover – Heavy Duty	31
Adhesive Thinner	22	TRS–10 Fiberglass Insert Blanket ..	22
Bungee Cord	22	Union Cover – White	14
Caulking – Silicone	21	Union Cover – Color	26
Caulking Guns	21	Union Cover – Heavy Duty	33
Cut/Curled Jacketing – White & Colors	20	Victaulic® Coupling Cover – White ..	15
End Cap Cover, Oval – White	13	Victaulic® Coupling Cover – Color ..	28
End Cap Cover, Oval – Color	27	Victaulic® Fitting Covers, Low Profile – White	16
End Cap Cover, Round – White	13	Victaulic® Fitting Covers, Low Profile – Color	29
End Cap Cover, Round – Color	27	Victaulic® Fitting Covers, Original – White	17
End Cap Cover, Round – Heavy Duty	35	Victaulic® Fitting Covers, Original – Color	30
Flange Cover – White	14	Vinyl Tape – 10 mil & 6 mil	21
Flange Cover – Color	26	Y–Strainer Cover – White	14
Flange Cover – Heavy Duty	33	Y–Strainer Cover – Color	26
Inline Reducer Cover – White	13	Y–Strainer Cover – Heavy Duty	33

Chart and Data Index

Application Details	6–9
Dimensions – Iron Pipe	36
Dimensions – Pipe Flange	37
Dimensions – Screwed Fittings	36
Dimensions – Victaulic® Fittings	37
Dimensions – Welded Fittings	36–37
Product Data Sheet	2–3
Sizing Charts – Fitting Covers/Jacketing	35
Sizing Charts – PVC Fitting Cover	10
Sizing Charts – PVC Jacketing	19
Sizing Charts – Victaulic® Fitting Covers	15

Terms and Conditions of Sale

Color Fittings:

All colored fittings are made to order and non-cancellable after they are produced, even if they have not yet been shipped.

Prices:

All prices are net F.O.B. Greensboro, NC; Cleveland, OH; or Stockton, CA and subject to change without notice. All orders are subject to prices prevailing at the time of shipment.

Standard Terms:

Net 30 days. All sales tax imposed by any federal, state, municipal or other legal government authority shall be paid by the customer. All payments are due in U.S. currency.

Minimum Sale:

Orders for less than \$150 list value shall be invoiced at list price, (no discount to apply), plus a \$25 handling charge.

Freight Allowance:

Freight will be prepaid and allowed on orders within the Continental U.S. having a list value of \$4,000.

Returns:

Returned merchandise will be accepted for credit only after written authorization and an explanation of restocking and freight charges have been sent to the customer. Any prior approved return shipment must be clearly identified with our assigned Return Goods Authorization Number (RGA#). Credit will be issued only after an inspection of the return goods has been taken.

Shipping Shortages and Damages:

All materials are carefully examined, counted and packaged prior to shipping. Any claims for corrections must be made within 10 days of receipt of goods. Our responsibility ceases when goods are transferred to a carrier in good condition and its receipt is obtained. Carriers are responsible for goods lost, damaged or delayed in transit. All materials should be carefully checked for damage and shortages before signing for freight delivery.

Warranty:

Speedline warrants all products to be free from defects in materials and workmanship under normal conditions of use and service. Our obligation under this warranty is limited and will only cover full replacement or credit for product which shall, within one year, after delivery to the original purchaser be returned with transportation charges prepaid and which our examination shall show to our satisfaction to have been defective. This warranty is expressly made in lieu of all other warranties, expressed or implied.

SPEEDLINE

Speedline® Corporation

6810 Cochran Road · Solon, OH 44139

Toll Free: 1.800.551.9759 · Fax: 1.440.914.9334 · www.speedlinepvc.com

Manufacturing and Distribution:

Ohio

6810 Cochran Road
Solon, OH 44139
Tel: 1.800.551.9759

North Carolina

109 Sands Road
Reidsville, NC 27320
Tel: 1.800.551.9760

California

4113 Gold River Lane
Stockton, CA 95215
Tel: 1-800.833.4500

Texas

2902 East 13th Street
Suite 200,
LaPorte, TX 77571
Tel: 713-670-9700

Specifications are subject to change without notice. All Speedline trademarks and trade names are the property of Speedline® Corporation. All other trademarks and trade names are the property of their respective companies.